

SC94

Potentiometer Input Standard Controller USERS' GUIDE

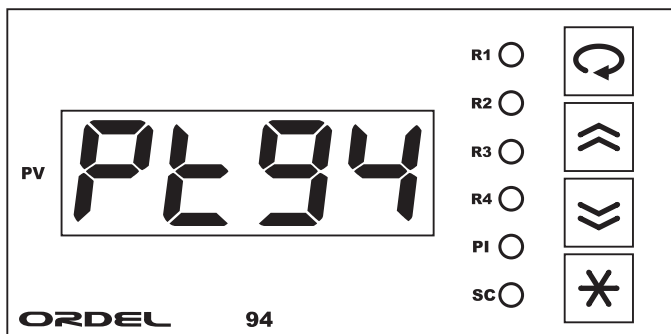

ORDEL



- Before using the device, please read the warnings below and this guide carefully. The accidents or damages resulting from not following the warnings included in this guide are under user's responsibility.
- This device is intended to be used by qualified personnel in industrial environments, do not use in houselike environments.
- Do not use the device at places where corrosive, flammable and explosive gases exist. Contact points may create electrical discharge and this may cause explosion or fire.
- Do not allow metal fragments or lead wire scraps or liquid matters to fall inside this device. Otherwise fire or electrical shck may happen.
- Take the necessary precautions in order to prevent accidents and damages that may result in case the device gets faulty.
- There is no fuse or switch that brings the device in power down state, these should be added to the system by the user.
- Sensor and signalling cables should not be routed close to the power cables or inductive load cables.
- Do not power up the device before the connections related with the device are performed in accordance with connection diagram.
- Do not power up the device before the connections related with the device are performed in accordance with the connection diagram. While the device is powered, do not touch on the terminals.
- Configuration settings at factory out should be changed according to the user's preferences. The accidents and damages resulting from incorrect configuration settings are under users' responsibility.
- Never disassemble, repair and modify the device. These should be carried out by authorized service.

SECTION	Page:
Safety Precautions	2
Contents	3
Description of the Device	4
Preparations	5
Connection Diagram	6
Product Code	8
Technical Specifications	9
Temperature Sensor Types	10
Display and Key Functions	11
Configuration	13
Configuration Page Parameters	15
Operator Page	22
Operator Page Parameters	23
Auto-Tune Operation	24
Serial Communication	25
Configuration Guide	29

Model PT94 devices are modular devices that have been designed to measure and control different types of processes variables and all modules can be configured separately. Complying international standards, reliability and user friendly usage features are the design principles of these devices. So that, they are ergonomic devices that can be used easily in many different industrial sectors.

- 1 Item 4 Digit Display**
- 6 Item Led Indicator**
- 1 Item Potentiometer Input (5K)**
- 1 Item Analog Output (0/4-20mA, 0/2-10V)**
- 4 Item Relay or Logic Output (24V)**
- 1 Item RS485 Communication Unit**
- 100-240Vac Universal or 24Vac/dc Supply Voltage**
- Isolation between Input/Output Modules**

- Auto-Tuning (Automatic settings of PID parameters)**
- Sensor Error Detection**
- 9 Different Relay Functions**
- ON/OFF, P, PI, PD, PID Controls**
- Linear and Time Proportioning Control Output**
- 100ms Sampling and Control Cycle**

Before using the device, please follow the instructions below according to the information in this guide.

- Model PT94 devices are modular devices, so that before using the device, control supply voltage and input/output modules if they are appropriate or not by the help of product code
- First of all, connect device to power supply and by using the configuration page, configure the device.
- After configuring the device, adjust set and hysteresis values of the relays which are selected as alarm in operator page.
- Power down the device and according to the connection diagram, apply other connections.
- Prepare the system which will be controlled to be run and power up the system and the device.
- If the control outputs of device will use PID and PID parameters are not entered manually, Run Auto-Tune in order to have the device to calculate these parameters automatically.
- In order to be sure that PID parameters are correct, use a new set value for device and observe the operation.
- Control all functions of the device by stepping through other operating modes.
- Finally, in order to prevent the unauthorized people to observe the system, make the necessary operation for security by entering the configuration page and return to the Process Screen.

This user guide is prepared by following the instruction order above. How these operations are made are explained in detailed in related sections.

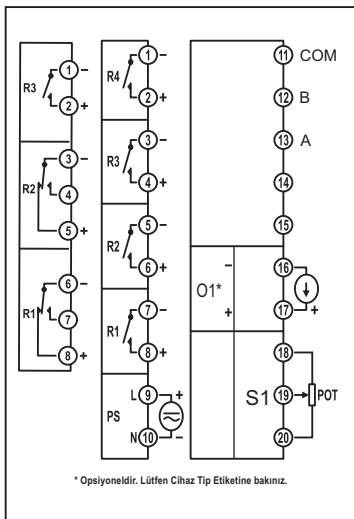
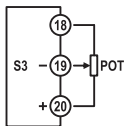

Diagram-1

Module	Explanation
S1	Potentiometer Input (5K)
O1	Analog Output Module (Content of this module is determined by product code and the function of this module is determined by "o IF" parameter that can be accessed from configuration page).
R1,R2,R3,R4	Relay Output Modules (Content of this module is determined by product code and the function of this module is determined by "r IF, r 2F, r 3F, r 4F" parameters that can be accessed from configuration page).
PS	Supply voltage input (Supply voltage is determined by product code).
LU	Rs485 Communication Module

Potentiometer Input *
(1000 - 5000Ω)



**RS485
Communication Module**

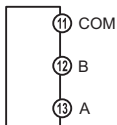

Power Supply *

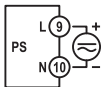

Relay Outputs *

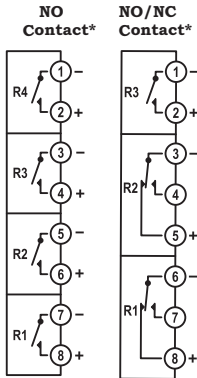

* These are optional. Please look to device sticker.

PT94 - _ _ _ / _ 0 / _ _ _ _

PS LU O1 R1 R2 R3 R4

Supply Voltage : _____
 0 = 100-240Vac (Universal)
 1 = 24Vac/dc

Communication Module : _____
 0 = N/A
 3 = RS485 Communication Unit

NOTE : If this module is coded to "3",
 Analog Output Module must be "0".

Analog Output Module : _____
 0 = N/A
 1 = 0/4-20mA Current Output
 2 = 0/2-10V Voltage Output

NOTE : If this module is coded to "1" or "2",
 Communication Module must be "0".

R1 Relay Output Modules : _____
 0 = N/A
 1 = NO Contact
 2 = 24V Logic Output (To drive SSR)
 3 = NO/NC Contact

R2 Relay Output Modules : _____
 0 = N/A
 1 = NO Contact
 2 = 24V Logic Output (To drive SSR)

Supply Voltage (PS)	100-240Vac/dc : +%10 -%15	24Vac/dc : +%10 -%20	
Power Consumption	6W,10VA		
Universal Sensor Input (S1)	Thermocouple : B,E,J,K,L,N,R,S,T,U		
	Two Wire Transmitter : 4-20mA		
	Resistance Thermometer : PT100		
	Current : 0/4-20mA		
	Voltage : 0-50mV, 0/2-10V		
Transmitter Supply (TX)	24Vdc (I _{sc} = 30mA)		
Analog Input Impedances	Thermocouple, mV : 10M Ω		
	Current : 10 Ω		
	Voltage : 1M Ω		
Analog Output (O1)	Current : 0/4-20mA (RL \leq	Voltage : 0/2-10V (RL \geq 1M Ω)	
Relay Outputs (R1,R2)	Contact : 250Vac, 5A	Logic Output : 24Vdc, 20mA	
Contact Lifetime	Without Load : 10.000.000 switching		
	With 250V, 3A Resistive Load : 100.000 switching		
Memory	100 years, 100.000 renewals		
Accuracy	+/- %0.2		
Sampling Period	100ms		
Environment Temperature	Operation : -10...+55C	Storage : -20...+65C	
Protection	Front Panel : IP54	Trunk : IP20	
Dimensions	Width : 96mm	Height : 48mm	Depth : 110mm
Panel cut-out Dimensions	92+/-0,5 mm x 45+/-0,5 mm		
Weight	320gr		

Sensor Type	Standard	Temperature Range	
		(°C)	(°F)
Type-B Thermocouple (Pt%18Rh-	IEC584-1	60, 1820	140, 3308
Type-E Thermocouple (Cr-Const)	IEC584-1	-200, 840	-328, 1544
Type-J Thermocouple (Fe-Const)	IEC584-1	-200, 1120	-328, 1562
Type-K Thermocouple (NiCr-Ni)	IEC584-1	-200, 1360	-328, 2480
Type-L Thermocouple (Fe-Const)	DIN43710	-200, 900	-328, 1652
Type-N Thermocouple (Nicrosil-	IEC584-1	-200, 1300	-328, 2372
Type-R Thermocouple (Pt%13Rh-	IEC584-1	-40, 1760	104, 3200
Type-S Thermocouple (Pt%10Rh-	IEC584-1	-40, 1760	104, 3200
Type-T Thermocouple (Cu-Const)	IEC584-1	-200, 400	-328, 752
Type-U Thermocouple (Cu-Const)	DIN43710	-200, 600	-328, 1112
Pt-100 Resistance Thermometer	IEC751	-200, 840	-328, 1544

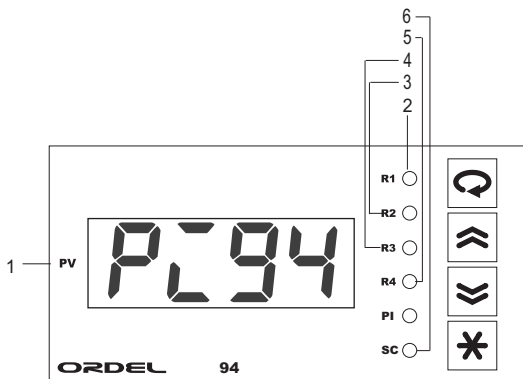

PROCESS-SCREEN:

Just after powering up the device, after showing program version for 2 seconds, "PV" display shows measured process value or error message and "ST" display shows the most used parameter depending to operation mode. This screen is called **Process-Screen**. During normal operations, this screen is used.

1	PV DISPLAY	Process value or error messages are shown in Process-Screen, other screens show the parameter name.
2	R1 LED	It indicates when "R1" relay is powered up.
3	R2 LED	It indicates when "R2" relay is powered up.
4	R3 LED	It indicates when "R3" relay is powered up.
5	R4 LED	It indicates when "R4" relay is powered up.
6	SC LED	It shows SC94 device.





SYMBOLISATION OF ALPHABETICAL CHARACTERS

A	B	C	D	E	F	G	H	I	J	K	L	M
<i>A</i>	<i>b</i>	<i>C</i>	<i>d</i>	<i>E</i>	<i>F</i>	<i>G</i>	<i>H</i>	<i>I</i>	<i>J</i>	<i>K</i>	<i>L</i>	<i>M</i>
N	O	P	Q	R	S	T	U	V	W	X	Y	Z
<i>n</i>	<i>o</i>	<i>P</i>	<i>q</i>	<i>r</i>	<i>S</i>	<i>t</i>	<i>U</i>	<i>v</i>	<i>W</i>	<i>X</i>	<i>Y</i>	<i>Z</i>

ERROR MESSAGES

<i>Err. 1</i>	Sensor connection is broken at "S1" input.
----	Process value is above the display scale.
----	Process value is below the display scale.

KEY FUNCTIONS

	If it is pressed shortly, first page is activated. Pressing for 2 seconds will activate the Process-Screen.
	It is used to change the parameter option or parameter value.
	It is used to change the parameter option or parameter value.
	In any page, pressing for a while activates the next parameter. While in Process-Screen, pressing for 5 seconds will start the Auto-Tune operation. For submit operations, it must be pressed for 2 seconds.

SC94 series include control devices that are designed for multi-purpose usage. So that they can be used in any environments that have appropriate input/output modules. These devices may work with different types of sensors and input signals and may control all outputs separately. So that, before using SC441 device, input/output types and functions, control types and usage preferences should be determined carefully.

According to the product code, SC441 series devices may have 1 analog input, 1 analog output and 2 relay output modules. Module types, functions and scales are determined with parameters which can be accessed in configuration page.

Furthermore, common parameters that determines the control type and operating mode, also necessary setting for control algorithm may be accessed in configuration page.

Before using an unconfigured device, firstly power on the device and make configuration by following the instructions below:

Entering the configuration page and setting up parameters:

- ◆ In order to enter the configuration page, press “[*]” and “[<]” keys simultaneously and continuously until “L2” message appears in “PV” display when device is energized.
- ◆ Set the security code by pressing “[>]” and “[<]” keys by setting the value of “SP” display to configuration page security code when “L2” message still appears in PV display (Default factory setting of this security code is “0”).
- ◆ If the security code is not valid when you have pressed “[<]” key, Process-Screen is to be reverted, otherwise first parameter of the configuration page is accessed.
- ◆ In parameter display, parameter name is displayed in “PV” display, preferences of the parameter setting is displayed in “SP” display.
- ◆ Now, you can access other configuration parameters in order by pressing “[<]” key .
- ◆ In order to change preferences of parameter setting, use “[>]” and “[<]” keys, in order to step to the next parameter use “[<]” key. A short time press of “[*]” key makes you to access the start of page, a long time press makes you to return the Process-Screen.
- ◆ Below, you can find a graphical representation of these instructions in **Figure-3**.
- ◆ **Note:** In order to step through in configuration page with parameter numbers displayed, press “[*]” and “[<]” keys simultaneously.

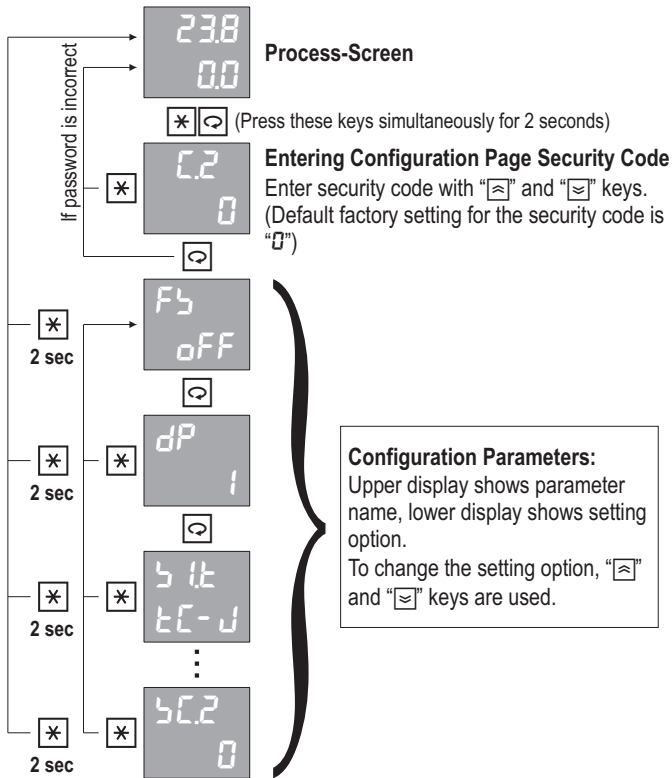

Figure-3

Detailed information about configuration page parameters can be found in the next section.

Par. 01



In order to restore the settings to the factory default, this parameter should be set to "on" and "☐" key should be pressed for two seconds.

Setting Preferences: OFF, on

Par. 02



It determines the decimal level (number of digits after dot) of all parameters which have a unit of "EU".

Setting Range : 0 - 3

Warning: When this parameter has been changed, all parameters which have a unit of "EU" should be set again.

Note: "EU", which is determined by "HU" parameter is a temperature unit for thermocouple or resistance thermometer measurements. Otherwise, it is an engineering unit that represents the measured variable.



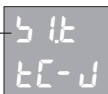



Par. 03

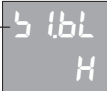

"S1" determines the sensor type which is connected to the universal sensor input. This sensor is used to measure the process value.

Setting Preferences: Table-1

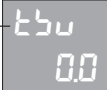
Table-1	No	Sensor Type
tC-b	0	Type-B Thermocouple (Pt%18Rh-Pt)
tC-E	1	Type-E Thermocouple (Cr-Const)
tC-J	2	Type-J Thermocouple (Fe-Const)
tC-K	3	Type-K Thermocouple (NiCr-Ni)
tC-L	4	Type-L Thermocouple (Fe-Const)
tC-n	5	Type-N Thermocouple (Nicrosil-Nisil)
tC-r	6	Type-R Thermocouple (Pt%13Rh-Pt)
tC-S	7	Type-S Thermocouple (Pt%10Rh-Pt)
tC-t	8	Type-T Thermocouple (Cu-Const)
tC-U	9	Type-U Thermocouple (Cu-Const)
r t	10	Pt-100 Resistance Thermometer
0-50	11	0-50mV
0-20	12	0-20mA
4-20	13	4-20mA
0-10	14	0-10V
2-10	15	2-10V

Par. 04		It determines the lower scale value of "S1" universal sensor input module. <hr/> <i>Setting Range</i> : -999.9 - 999.9 <i>Unit</i> : EU
Par. 05		It determines the higher scale value of "S1" universal sensor input module. <hr/> <i>Setting Range</i> : -999.9 - 999.9 <i>Unit</i> : EU
Par. 06		It determines the value which scala will be set to when the universal sensor input connection is broken. <hr/> <i>Setting Preferences</i> : L (Low value) , H (High value)
Par. 07		It determines the temperature unit for the measurements of thermocouples or resistance thermometers. <hr/> <i>Setting Preferences</i> : °C (°C), °F (°F)
Par. 08		While measuring with thermocouples or resistance thermometers, in order to correct measurement errors, it is added to measured value. <hr/> <i>Setting Range</i> : -100.0 - 100.0 <i>Unit</i> : EU
Par. 09		It determines the time constant of digital filter that is applied to analog inputs. If this value is increased, reading stability increases but reading speed decreases. <hr/> <i>Setting Range</i> : 0.0 - 10.0 <i>Unit</i> : sec
Par. 10		"O1" determines Analog output function. <hr/> <i>Setting Preferences</i> : Table-4

Tablo-4	No	Analog Output Functions
oFF	0	No
PtO	1	Positif direction of PID control output.

Par. 11



It determines the type of "O1" analog output module.

Setting Preferences : Table-5

Table-5	No	Analog Output Type
0-20	0	0-20mA
20-0	1	20-0mA
4-20	2	4-20mA
20-4	3	20-4mA
0-10	4	0-10V
10-0	5	10-0V
2-10	6	2-10V
10-2	7	10-2V

Note: In order to be able to use the first four preferences, this module should be identified as being "0/4-20mA" in product code. As for the last four preferences, "0/2-10V" should be used as identifying code.

Par. 12



It determines the function of "R1" relay output module.

Setting Preferences : Table-6

Table-6	No	Relay Function	
OFF	0	N/A	
ULC	1	Upper Limit Control	ALARMS
LLC	2	Lower Limit Control	
ULA	3	Upper Limit Alarm	
LLA	4	Lower Limit Alarm	

UdR	5	Upper Deviation Alarm	ALARMS	
LdR	6	Lower Deviation Alarm		
obR	7	Outside Band Alarm		
IbR	8	Inside Band Alarm		
PCo	9	Positive directed PID control output		

Note: Hatched areas are hysteresis areas and hysteresis of each relay is determined with its " $Hh.n$ " parameter. (" N " represents the relay number)

"1" in table means that related relay is powered on and "0" means powered off.



Par. 13		It determines the function of "R2" relay output module.	Setting Preferences : Table-6
Par. 14		It determines the function of "R3" relay output module.	Setting Preferences : Table-6
Par. 15		It determines the function of "R4" relay output module.	Setting Preferences : Table-6
Par. 16		It determines the lower limit value of all set values.	Setting Range : +99.9 - [SPHL] Unit : EU
Par. 17		It determines the upper limit value of all set values.	Setting Range : [SPLL] - 999.9 Unit : EU

Par. 18	<div style="border: 1px solid black; padding: 5px; background-color: #cccccc;">CF</div> <div style="border: 1px solid black; padding: 5px; background-color: #cccccc;">rEu</div>	<p>It determines the control form (direction).</p> <p><i>Setting Preferences:</i> d\bar{c}r (While process value is increasing, output increases too), rEu (While process value is decreasing, output decreases too)</p>
Par. 19	<div style="border: 1px solid black; padding: 5px; background-color: #cccccc;">PoPb</div> <div style="border: 1px solid black; padding: 5px; background-color: #cccccc;">oFF</div>	<p>It determines the proportional band of positive directed PID control output.</p> <p><i>Setting Range:</i> oFF (ON/OFF control), 0.1 - Unit : EU</p>
Par. 20	<div style="border: 1px solid black; padding: 5px; background-color: #cccccc;">It</div> <div style="border: 1px solid black; padding: 5px; background-color: #cccccc;">oFF</div>	<p>Integral time constant.</p> <p><i>Setting Range:</i> oFF (Closed), 1 - 5000 Unit : sec</p>
Par. 21	<div style="border: 1px solid black; padding: 5px; background-color: #cccccc;">dt</div> <div style="border: 1px solid black; padding: 5px; background-color: #cccccc;">oFF</div>	<p>Differrantial time constant.</p> <p><i>Setting Range:</i> oFF (Closed), 0.1 - 999.9 Unit : sec</p>
Par. 22	<div style="border: 1px solid black; padding: 5px; background-color: #cccccc;">CP</div> <div style="border: 1px solid black; padding: 5px; background-color: #cccccc;">2.0</div>	<p>It determines the period of a control cycle.</p> <p><i>Setting Range:</i> 0.1 - 500 Unit : sec</p> <p>Note: In order to prevent from oscillations caused from control period, control period should be selected minimum to system dead time.</p>
Par. 23	<div style="border: 1px solid black; padding: 5px; background-color: #cccccc;">CoLL</div> <div style="border: 1px solid black; padding: 5px; background-color: #cccccc;">-100.0</div>	<p>It determines the lower limit of PID control output.</p> <p><i>Setting Range:</i> -100.0 - [CoHL] Unit : %</p>
Par. 24	<div style="border: 1px solid black; padding: 5px; background-color: #cccccc;">CoHL</div> <div style="border: 1px solid black; padding: 5px; background-color: #cccccc;">100.0</div>	<p>It determines the higher limit of PID control output.</p> <p><i>Setting Range:</i> [CoLL] - 100.0 Unit : %</p>
Par. 25	<div style="border: 1px solid black; padding: 5px; background-color: #cccccc;">CobL</div> <div style="border: 1px solid black; padding: 5px; background-color: #cccccc;">0.0</div>	<p>It determines the initial value of PID control output. (When integral is closed, it is the control output value which process value and set value are equal)</p> <p><i>Setting Range:</i> -100.0 - 100.0 Unit : %</p>
Par. 26	<div style="border: 1px solid black; padding: 5px; background-color: #cccccc;">AtF</div> <div style="border: 1px solid black; padding: 5px; background-color: #cccccc;">P\bar{c}d</div>	<p>It determines the control type for Auto-Tune operation.</p> <p><i>Setting Preferences:</i> P, P\bar{c}, P\bar{c}d (P, PI, PID)</p>

CONFIGURATION PAGE PARAMETERS

20

Par. 27	<p>ACP</p> <p>on</p>	<p>It allows the control periode is calculated automatically by Auto-Tune operation.</p> <p>Setting Preferences: oFF(No) , on(Yes)</p>
Par. 28	<p>AtSP</p> <p>oFF</p>	<p>If user wants the Auto-Tune operation to make for a certain set value, it determines this set value.</p> <p>Setting Range : oFF(Closed) , -999.9 - 999.9 Unit : EU</p>
Par. 29	<p>AtHr</p> <p>2.0</p>	<p>Hysterisis value for Auto-Tune operation. It should be set to 5-20 times of system instability.</p> <p>Setting Range : 0.1 - 100.0 Unit : EU</p>
Par. 30	<p>Addr</p> <p>1</p>	<p>It determines the serial communication address. All addresses should be unique that are connected to a serial communication line.</p> <p>Setting Range : oFF(Closed) , 1 - 255 Unit: EU</p>
Par. 31	<p>bAud</p> <p>9.6</p>	<p>It determines the serial connection speed.</p> <p>Setting Preferences : 9.6 , 19.2 , 38.4 Unit : Kbps</p>
Par. 32	<p>Prty</p> <p>Even</p>	<p>It determines the parity type in serial communication.</p> <p>Setting Preferences : nonE(None) , odd(Odd) , Even(Even)</p>
Par. 33	<p>CSPY</p> <p>on</p>	<p>Permission for changing the control set value by the operator.</p> <p>Setting Preferences: oFF(Off) , on(On)</p>
Par. 34	<p>ASPY</p> <p>on</p>	<p>Permission for changing the "SEn" set value that belongs to relays.</p> <p>Setting Preferences: oFF(Off) , on(On)</p>
Par. 35	<p>HYSP</p> <p>on</p>	<p>Permission for changing the hysteresis ("HYn") value by the operator.</p> <p>Setting Preferences: oFF(Off) , on(On)</p>
Par. 36	<p>At</p> <p>on</p>	<p>Permission for starting the Auto-Tune operation.</p> <p>Setting Preferences: oFF(Off) , on(On)</p>

Par. 37		It determines the "CoL" parameter is shown or not which represents the PID control output level in operator page.	
		<i>Setting Preferences:</i> OFF(Off) , ON(On)	
Par. 38		While in operator parameters, it determines the automatic return time to Process-Screen.	
		<i>Setting Range :</i> OFF(Off) , 1 - 25	<i>Unit :</i> sec
Par. 39		It determines the security code for Configuration page.	
		<i>Setting Range :</i> 1999 - 9999	

Existing configuration determines which parameters will be used in operator page and only necessary parameters are displayed. These parameters which are determined in configuration are used in normal operation conditions. So, While in Process Screen, by pressing key " \square " key, user can access these parameters in any time and by pressing the " \ast " key, user returns to Process-Screen again. Setting permission of the changeable parameters can be set with the related parameters in configuration page. While in any parameter in operator page, if user does not press any key, Process-Level is to be returned after the time which is determined by "RrL" parameter, pass.

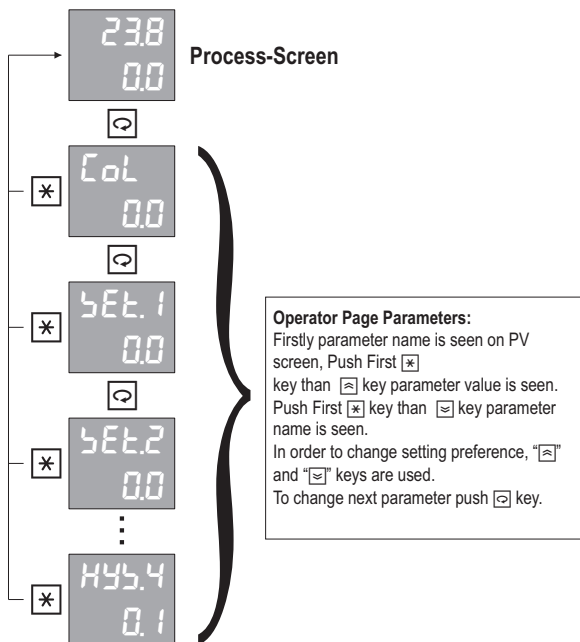

Detailed information about operator page parameters can be found in the next section.

<p>CoL 0.0</p>	<p>It displays the level of PID control output. In order to make this parameter visible, "CoP" parameter which is in configuration page should be selected as being "on".</p>	<p>Unit : %</p>
<p>SEt.1 0.0</p>	<p>It determines the set value of "R1" module. In order to make this parameter visible, "r1F" parameter should be selected as ALARM.</p>	<p>Setting Range : [SPLL] - [SPHL] Unit : EU</p>
<p>SEt.2 0.0</p>	<p>It determines the set value of "R2" module. In order to make this parameter visible, "r2F" parameter should be selected as ALARM.</p>	<p>Setting Range : [SPLL] - [SPHL] Unit : EU</p>
<p>SEt.3 0.0</p>	<p>It determines the set value of "R3" module. In order to make this parameter visible, "r3F" parameter should be selected as ALARM.</p>	<p>Setting Range : [SPLL] - [SPHL] Unit : EU</p>
<p>SEt.4 0.0</p>	<p>It determines the set value of "R4" module. In order to make this parameter visible, "r4F" parameter should be selected as ALARM.</p>	<p>Setting Range : [SPLL] - [SPHL] Unit : EU</p>
<p>HYS 0.1</p>	<p>It determines the control hysteresis value. In order to make this parameter visible, one of the proportional band should be selected as being "oFF".</p>	<p>Setting Range : 0.1 - 100.0 Unit : EU</p>
<p>HYS.1 0.1</p>	<p>It determines the hysteresis value of "R1" module. In order to make this parameter visible, "r1F" parameter should be selected as being ALARM.</p>	<p>Setting Range : LEL (Locked) , 0.1 - 100.0 Unit : EU</p>
<p>HYS.2 0.1</p>	<p>It determines the hysteresis value of "R2" module. In order to make this parameter visible, "r2F" parameter should be selected as being ALARM.</p>	<p>Setting Range : 0.1 - 100.0 Unit : EU</p>
<p>HYS.3 0.1</p>	<p>It determines the hysteresis value of "R3" module. In order to make this parameter visible, "r3F" parameter should be selected as being ALARM.</p>	<p>Setting Range : 0.1 - 100.0 Unit : EU</p>
<p>HYS.4 0.1</p>	<p>It determines the hysteresis value of "R4" module. In order to make this parameter visible, "r4F" parameter should be selected as being ALARM.</p>	<p>Setting Range : 0.1 - 100.0 Unit : EU</p>

While configuring model PT94 devices, if PID parameters (P_{OPb} , $ROPB$, z_t , d_t , CP) are default factory parameters, control outputs operate in ON/OFF mode. In order to begin operating with PID parameters, these parameters should be determined manually or Auto-Tune operation should be done.

Because every process has different characteristics, PID parameters should be different too. Auto-Tune operation calculates the optimum PID parameters and saves them.

Before starting to operate Auto-Tune operation, " $RtSP$ " and " $RtHr$ " parameters should be set and " Rt " parameter should be " ON ". If " $RtSP$ " parameter is " OFF ", Auto-Tune operates by using the set value at that time. In order to get the optimum PID parameters, selected set value should be at about the middle of process' whole power.

After having appropriate settings, while in Process-Screen, press the " \square " key for 5 seconds to start the Auto-Tune operation then " Rt " message flashes in "ST" display. In order to have correct results, nobody should interfere with the system. While in Auto-Tune operation, the device calculates and saves new PID parameters after doing ON/OFF control for 2 or 3 oscillations with the determined set value and hysteresis. After finishing the Auto-Tune operation, " Rt " message in display disappears and the device begins to control the system (process) using the new PID parameters. After finishing the Auto-Tune operation, " Rt " parameter in configuration page should be changed to " OFF " state again. While in the Auto-Tune state, pressing the " \ast " key cancels the operation.

If user wants a device to operate in ON/OFF mode instead of PID, PID parameters should be set to default factory output.

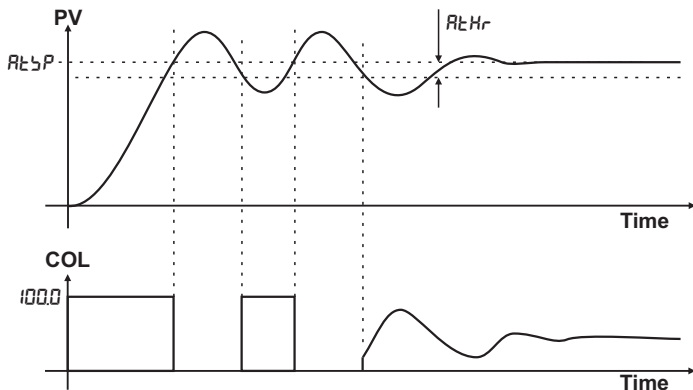

This devices are designed to be communicated in slave mode with MODBUS RTU protocol. All parameters and registers can be accessed with this communication type. Parameters can be read or can be set to a value.

Serial communication is established with Half-Duplex RS485 line. 32 devices can be connected to one RS485 line.

The cable which is used in communication line should be a data cable that is compatible with Half-Duplex RS485 communication and this cable should be connected parallel to all devices as a single line. Both cable ends should be terminated with a appropriate resistance. A communication line which is appropriate for 9600 Bps data tranmission speed can be up to 1000m.

Each device on serial communication line should have an unique address between 1 and 255 but all devices in this line should have same speed and parity type. Communication address, speed and parity type of these devices are determined with " *Addr*, *bRÜd* ve *PrŁY*" parameters which are in configuration page.

Below, you can find information about functions which are supported by MODBUS RTU, parameter addresses and others in tables.

Supported Standard MODBUS RTU Functions:

Function 01 = Read Coils

Function 03 = Read Holding Registers

Function 05 = Write Single Coil

Function 06 = Write Single Register

Function 16 = Write Multiple Registers

BIT Type Parameters (COILS)

Address	Explanation (1 / 0)	Set Perm.
0	Auto-Tune (ON / OFF)	
1	"R1" relay module (ON / OFF)	
2	"R2" relay module (ON / OFF)	
3	"R3" relay module (ON / OFF)	
4	"R4" relay module (ON / OFF)	
5	ERR1 Error (Yes / No)	No
6	ERR2 Error (Yes / No)	No
7	ERR3 Error (Yes / No)	No
8	General Error (Yes / No)	No

REGISTER Type Parameters (REGISTERS)

Adres	Explanation	Setting Range		Mul.	Unit	Set Perm.
0	Valid decimal point	0	3	1		No
1	Measured process value	-1999	9999	10 ^{DP}	EU	No
2	Control set value	-1999	9999	10 ^{DP}	EU	
3	PID control output level	-1000	1000	10	%	
4	Operating mode	0	2	1		
5	Measured process value from 1. sensor	-1999	9999	10 ^{DP}	EU	No
6	Measured process value from 2. sensor	-1999	9999	10 ^{DP}	EU	No
7	Measured process value from 3. sensor	-1999	9999	10 ^{DP}	EU	No
8	Instantaneous set value	-1999	9999	10 ^{DP}	EU	No
9	Valve movement direction	0	2	1		No
10	Valve location	0	1000	10	%	No

Addr.	Explanation	Setting Range		Mul.	Unit.	Set Perm.
20	1.Optional set point	-1999	9999	10^DP	EU	
21	2.Optional set point	-1999	9999	10^DP	EU	
22	3.Optional set point	-1999	9999	10^DP	EU	
23	4.Optional set point	-1999	9999	10^DP	EU	
24	5.Optional set point	-1999	9999	10^DP	EU	
25	6.Optional set point	-1999	9999	10^DP	EU	
26	7.Optional set point	-1999	9999	10^DP	EU	
27	8.Optional set point	-1999	9999	10^DP	EU	
28	Set value of "R1" module	-1999	9999	10^DP	EU	
29	Set value of "R2" module	-1999	9999	10^DP	EU	
30	Set value of "R3" module	-1999	9999	10^DP	EU	
31	Set value of "R4" module	-1999	9999	10^DP	EU	
32	Control hysteresis value	1	1000	10^DP	EU	
33	Hysteresis value of "R1" module	0	1000	10^DP	EU	
34	Hysteresis value of "R2" module	0	1000	10^DP	EU	
35	Hysteresis value of "R3" module	0	1000	10^DP	EU	
36	Hysteresis value of "R4" module	0	1000	10^DP	EU	

Not: Please contact to producer firm for the communication information about other parameters

Before start to use the device, be sure these steps are done.

- Be sure that \hookrightarrow IL parameter is chosen suitable with the sensor type you want to use. (S1 Universal sensor input is in the page 15 table - 1)
- Be sure \hookrightarrow ILL parameter is set to lowest value by sensor scale of S1
- Be sure \hookrightarrow IHL parameter is set to highest value by sensor scale of S1
- Be sure r $1F, r2F, r3F, r4F$ parameters are chosen suitable with the function of relay. (Relay output number is optional. It can be change by device model. Relay function table is in the page 19 and 20 table - 6)
- Be sure o $1F$ parameter is set to suitable function of analog output you want to use. (Analog output number is optional. It can be change by device model. Analog output functions table is in the page 18 table - 4)
- Be sure o IL parameter is chosen suitable with the current/voltage output type shown on the device label (Analog output number is optional. It can be change by device model. Analog output type table is in the page 18 table - 5)
- Be sure o ILL parameter is set to lowest value of analog output scale you want to use.(Analog output number is optional. It can be change by device model)
- Be sure o IHL parameter is set to highest value of analog output scale you want to use.(Analog output number is optional. It can be change by device model)

To make PID Controll :

- If you want to use Relay Output Module, be sure:

r $1F, r2F, r3F, r4F$ parameters (the ones you want use in PID control) should set to suitable functions between $PLO, nLO, POF, nOF, oPN, LLS, dLS$ options that chosen from relay functions table

- If you want to use Analog Output Module, be sure:

o $1F$ parameter is set to proper function between PLO, nLO options that chosen from analog output function table.

To make PID control with your device, you can enter parameters manually or automatically.

If you know the characterise of system, you can enter manually these parameters:

- Proportional band value of positive PID control output P_{oPb} , Proportional band value of negative PID control output n_{oPb} , Integral time constant $\int t$, Differential time constant $d t$, and Control period sampling time $\int P$.

You can start Auto-Tune function and device will calculate PID control parameters automatically.

To start Auto-Tune process :

- Enter temperature value of process set point to $RtSp$ parameter. This value should be around mid points of process' full power .
- Enter hysteresis value of process set point to $RtHr$ parameter. This value arranges the sensitivity of Auto-Tune process.
- Set Rt parameter on .

When the device main screen, press "" button for 5 seconds.

While Auto-Tune operation is working, device display shows blinking Rt . This expression fades away when the Auto-Tune process is finished.

To cancel the Auto-Tune operation, press "" button while operation is running.

www.ordel.com.tr

ORDEL Ltd. Őti. 6.Cad. No:13/4 AŐađı Öveçler/ANKARA Tel:+90 312 481 86 89 (PBX) Fax: +90 312 481 60 68

ORDEL