

PC991

Step Control Devices USER GUIDE



ORDEL



- Before using the device, please read the warnings below and this guide carefully. The accidents or damages resulting from not following the warnings included in this guide are under user's responsibility.
- This device is intended to be used by qualified personnel in industrial environments, do not use in houselike environments.
- Do not use the device at places where corrosive, flammable and explosive gases exist. Contact points may create electrical discharge and this may cause explosion or fire.
- Do not allow metal fragments or lead wire scraps or liquid matters to fall inside this device. Otherwise fire or electrical shock may happen.
- There is no fuse or circuit breaker on the device. They must be connected externally by the user.
- Take the necessary precautions in order to prevent accidents and damages that may result in case the device gets faulty.
- Sensor and signalling cables should not be routed close to the power cables or inductive load cables.
- Do not power up the device before the connections related with the device are performed in accordance with connection diagram.
- Do not energize the device before making connections in accordance with the connection diagram and do not touch the terminals when the device is energized.
- Configuration settings at factory out should be changed according to the user's preferences. The accidents and damages resulting from incorrect configuration settings are under user's responsibility.
- Device is identified and declared by the ministry lifespan of ten years.
- Never disassemble, repair and modify the device. These should be carried out by

SECTION	Page No:
Warnings.....	2
Contents	3
Description of the device.....	4
Preparation steps use	5
Connection Diagram.....	6
Product Code.....	8
Technical Specifications.....	9
Temperature Sensors.....	10
Display and Key Functions	11
Configuration	13
Configuration Page Parameters	15
Program Creation	28
Program Page Parameters	30
Operator Page	32
Operator Page Parameters	33
Auto-Tune Operation.....	35
Operating Modes.....	36
Determining Set Value Remotely.....	37
Proportional Motor Valve Control.....	38
Executing Programs	39
Serial Communication.....	41
Configuration Guide	47

Model PC991 devices are modular devices that have been designed to measure and control different types of processes variables and all modules can be configured separately. Complying international standards, reliability and user friendly usage features are the design principles of these devices. So that, they are ergonomic devices that can be used easily in many different industrial sectors.

- 2 Item 4 Digit, 1 Item 3 Digit Numeric Display
- 1 Item 21 LED Bar Indicator
- 6 Item LED Display
- 1 Item Transmitter Supply Output (24Vdc)
- 1 Item Universal Sensor Input (TC, RT, mA, mV, V)
- 1 Item Auxiliary Analog Input (0/4-20mA)
- 1 Item Potentiometer Input (100-1500 Ω)
- 3 Item Numerical Input (15V)
- 1 Item RS485 Communication Unit
- 2 Item Analog Output (0/4-20mA, 0/2-10V)
- 4 Item Relay or Logic Output (24V)
- 100-240Vac Universal or 24Vac/dc Supply
- Isolation between Input/Output Modules

- 800 Step, 100 Program Step Control
- Programming Ability of Relays in Different Steps
- 7 Different Power-Cut Action
- Proportional Valve Control with Position Feedback
- Proportional Valve Control Without Feedback
- PID Heating/Cooling
- Auto-Tuning (Automatic settings of PID parameters)
- Automatic/Manual/Program Operating Modes
- Bumpless Transfer Ability
- Sensor Error Detection
- Remote Set Point (Determining Set Point Remotely)
- 8 Item Optional Set Point
- Ramp Functions
- Retransmission (For Process and Set Values)
- 18 Different Relay Functions
- ON/OFF, P, PI, PD, PID Control
- Linear and Time Proportioning Control Output
- 100ms Sampling and Control Cycle
- Standard MODBUS RTU Communication Protocol
- Master-Slave, Cascade Control Applications

Before using the device, please follow the instructions below according to the information in this guide.

- Model PC991 devices are modular devices, so that before using the device, control supply voltage and input/output modules if they are appropriate or not by the help of product code.
- Supply on the supply voltage before making other connections to the device. Enter the configuration page and make the most appropriate configuration for your system.
- After configuring the device, enter program page and create your programs.
- Adjust set and hysteresis values of the relays which are selected as alarm in operator page.
- Power down the device and according to the connection diagrams
- Prepare the system which will be controlled to be run and power up the system and the device.
- If the control outputs of device will use PID and PID parameters are not entered manually, Run Auto-Tune in order to have the device to calculate these parameters automatically.
- In order to be sure that PID parameters are correct, use a new set value for device and observe the operation.
- Control all functions of the device by stepping through other operating modes.
- Finally, in order to prevent the an authorized people to observe the system, make the necessary operation for security by entering the configuration page and return to the process screen.

This user guide is prepared by following the instruction order above. How these operations are made are explained in detailed in related sections.

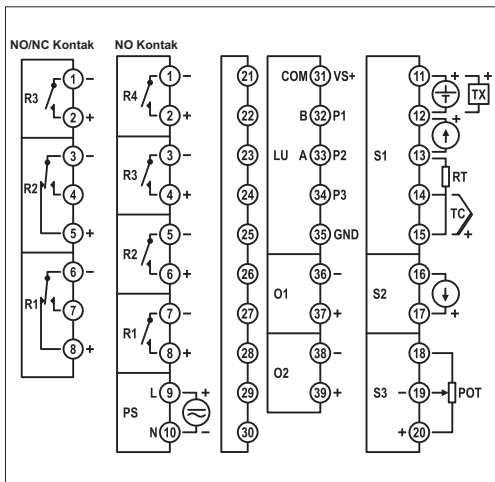
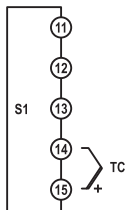

Diagram-1

Module	Explanation
S1	Universal Sensor Input Module (This sensor that is used to measure process value should be connected to the terminal which is identified with suitable
S2	0/4-20mA Auxiliary Analog Input Modul (Function of this module is determined by "S2F" parameter that can be accessed from configuration page).
S3	100-1500Ω Potentiometer Input Module (Function of this module is determined by "S3F" parameter that can be accessed from configuration page).
LU	Logic Input Module (Content of this module is determined by product code and the function of this module is determined by "LUF" parameter that can be accessed from configuration page).
O1,O2	Analog Output Module (Contents of this module is determined by product code and the function of this module is determined by "O1F" ve "O2F" parameters that can be accessed from configuration page).
R1,R2,R3,R4	Relay Output Modules (Content of this module is determined by product code and the function of this module is determined by "R1F, R2F, R3F, R4F"
PS	Supply Voltage Input (Supply voltage is determined by product code).

TC Input
(B,E,J,K,L,N,R,S,T,U)



Current Input (mA)

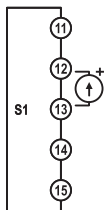

Aux. Current Input (mA)

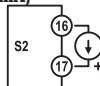

Analog Outputs *
(0-20mA/0-10V)

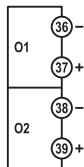

RT Input (3 Wire)

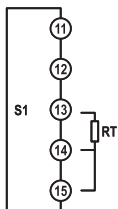

Voltage Input (V)

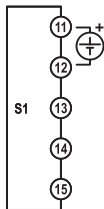

Proportional Supply back connection
(100 - 1500Ω)

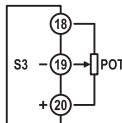

Relay/SSR Outputs *

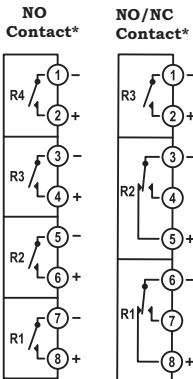

RT Input (2 Wire)

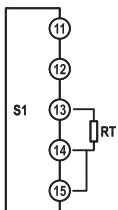

Transmitter Supply
(24Vdc/30mA)

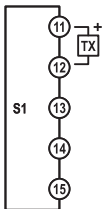

RS-485 Communication Connect*
(MODBUS - RTU)



Logic Inputs *
(VS+=15V)



Supply Connection *

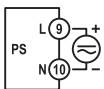

* It is optional. Please refer to the appliance type label.

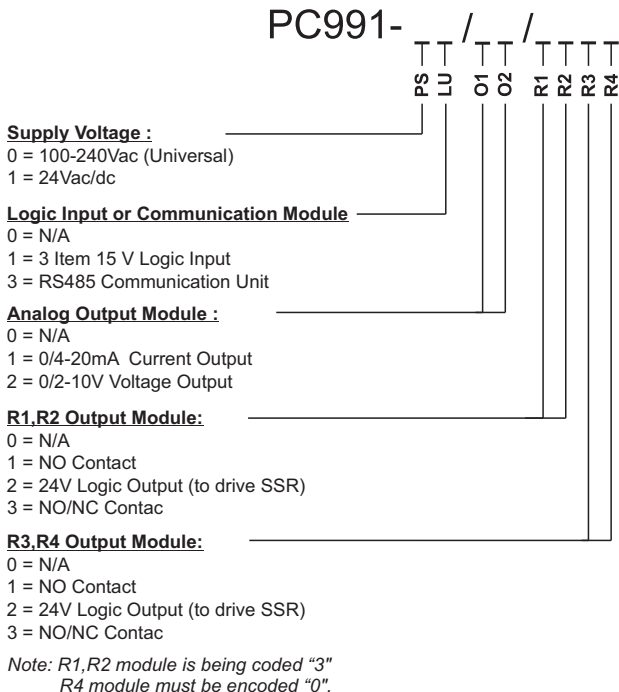

Relay output modules can be identified as contact or logic output in product code. But in this user's guide relay term is used to represent both.

Power Supply (PS)	100-240Vac/dc : +%10 -%15	24Vac/dc : +%10 -%20	
Power Consumption	6W,10VA		
Universal Sensor Input (S1)	Thermocouple : B,E,J,K,L,N,R,S,T,U		
	Two Wire Transmitter : 4-20mA		
	Resistance Thermometer : PT100		
	Current : 0/4-20mA		
	Voltage : 0-50mV, 0/2-10V		
Auxiliary Analog Input (S2)	0/4-20mA		
Potentiometer Input (S3)	100-1500Ω		
Transmitter Supply (TX)	24Vdc (I _{sc} = 30mA)		
Analog Input Impedance	Thermocouple, mV : 10MΩ		
	Current : 10Ω		
	Voltage : 1MΩ		
Analog Outputs (O1,O2)	Current : 0/4-20mA (RL ≤	Voltage : 0/2-10V (RL ≥ 1MΩ)	
Relay Outputs (R1,R2,R3,R4)	Contact : 250Vac, 5A	Logic Output : 24Vdc, 20mA	
Contact Lifetime	Without Load : 10.000.000 switching		
	250V, 5A Resistive Load : 100.000 switching		
Memory	100 yıl, 100.000 renewals		
Accuracy	+/- %0.2		
Sampling Period	100ms		
Environment Temperature	Operation : -10...+55C	Storage : -20...+65C	
Protection	Front Panel : IP54	Trunk : IP20	
Dimensions	Width : 96mm	Height : 96mm	Depth : 110mm
Panel cut-out Dimensions	92+/-0,5 mm x 92+/-0,5 mm		
Weight	430gr		

Sensor Type	Standard	Temperature Range	
		(°C)	(°F)
Type-B Thermocouple (Pt%18Rh-	IEC584-1	60, 1820	140, 3308
Type-E Thermocouple (Cr-Const)	IEC584-1	-200, 840	-328, 1544
Type-J Thermocouple (Fe-Const)	IEC584-1	-200, 1120	-328, 1562
Type-K Thermocouple (NiCr-Ni)	IEC584-1	-200, 1360	-328, 2480
Type-L Thermocouple (Fe-Const)	DIN43710	-200, 900	-328, 1652
Type-N Thermocouple (Nicrosil-	IEC584-1	-200, 1300	-328, 2372
Type-R Thermocouple (Pt%13Rh-	IEC584-1	-40, 1760	104, 3200
Type-S Thermocouple (Pt%10Rh-	IEC584-1	-40, 1760	104, 3200
Type-T Thermocouple (Cu-Const)	IEC584-1	-200, 400	-328, 752
Type-U Thermocouple (Cu-Const)	DIN43710	-200, 600	-328, 1112
Pt-100 Resistance Thermometer	IEC751	-200, 840	-328, 1544

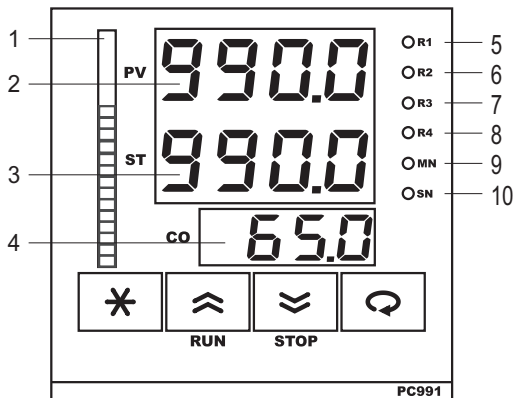

PROCESS-SCREEN:

Just after powering up the device, after showing program version for 2 seconds, "PV" display shows measured process value or error message and "SP" display shows the most used parameter depending to operation mode. This screen is called **Process-Screen**. During normal operations, this screen is used.

1	BAR INDICATOR	This indicator is only activated in Process-Screen and its function is determined by "bdf" parameter that can be accessed from configuration page.
2	PV DISPLAY	Process value or error messages are shown in Process-Screen, other screens show the parameter name.
3	ST DISPLAY	In Process-Screen, this display's function is determined according to operation mode. Other screens show the parameter value.
4	CO DISPLAY	This indicator is only activated in Process-Screen and it shows the valve position or control output level according to control type.
5	R1 LED	It indicates when "R1" relay is powered up.
6	R2 LED	It indicates when "R2" relay is powered up.
7	R3 LED	It indicates when "R3" relay is powered up.
8	R4 LED	It indicates when "R4" relay is powered up.
9	MN LED	It indicates when manual control is on.
10	SN LED	It indicates when program control mode is on and while running program it blinks with a period of 1 second.





DISPLAY OF ALPHABETIC CHARACTERS

A	B	C	D	E	F	G	H	I	J	K	L	M
<i>A</i>	<i>b</i>	<i>C</i>	<i>d</i>	<i>E</i>	<i>F</i>	<i>G</i>	<i>H</i>	<i>I</i>	<i>J</i>	<i>K</i>	<i>L</i>	<i>M</i>
N	O	P	Q	R	S	T	U	V	W	X	Y	Z
<i>n</i>	<i>o</i>	<i>P</i>	<i>q</i>	<i>r</i>	<i>s</i>	<i>t</i>	<i>U</i>	<i>v</i>	<i>W</i>	<i>X</i>	<i>Y</i>	<i>Z</i>

ERROR MESSAGES

<i>Err.1</i>	Sensor connection is broken at "S1" input.
<i>Err.2</i>	Signal is broken at "S2" input.
<i>Err.3</i>	Potentiometer at "S3" input failed.
----	Process value is above the display scale.
----	Process value is below the display scale.

KEY FUNCTIONS

	While in Process-Screen, if it is pressed shortly, locked relays are resetted. Pressing for 5 seconds will change the operating mode. While in other screens, it is used to revert to the first page. Pressing for 2 seconds will activate the Process-Screen.
	It is used to change the parameter option or parameter value.
	It is used to change the parameter option or parameter value.
	In any page, pressing for a while activates the next parameter. While in Process-Screen, pressing for 5 seconds will start the Auto-Tune operation. For submit operations, it must be pressed for 2 seconds.

PC991 series include control devices that are designed for multi-purpose usage. So that they can be used in any environments that have appropriate input/output modules. These devices may work with different types of sensors and input signals and may control all outputs separately. So that, before using PC991 device, input/output types and functions, control types and usage preferences should be determined carefully.

According to the product code, PC991 series devices may have 3 analog input, 3 logic input, 2 analog output and 4 relay output modules. Module types, functions and scales are determined with parameters which can be accessed in configuration page.

Furthermore, common parameters that determines the control type and operating mode, also necessary setting for control algorithm may be accessed in configuration page.

Before using an unconfigured device, firstly power on the device and make configuration by following the instructions below:

Entering the configuration page and setting up parameters:

- ◆ In order to enter the configuration page, press “[*]” and “[<]” keys simultaneously and continuously until “L2” message appears in “PV” display when device is energized.
- ◆ Set the security code by pressing “[>]” and “[<]” keys by setting the value of “SP” display to configuration page security code when “L2” message still appears in PV display (Default factory setting of this security code is “0”).
- ◆ If the security code is not valid when you have pressed “[<]” key, Process-Screen is to be reverted, otherwise first parameter of the configuration page is accessed.
- ◆ In parameter display, parameter name is displayed in “PV” display, preferences of the parameter setting is displayed in “ST” display.
- ◆ Now, you can access other configuration parameters in order by pressing “[<]” key .
- ◆ In order to change preferences of parameter setting, use “[>]” and “[<]” keys, in order to step to the next parameter use “[<]” key. A short time press of “[*]” key makes you to access the start of page, a long time press makes you to return the Process-Screen.
- ◆ Below, you can find a graphical representation of these instructions in **Figure-3**.
- ◆ **Note:** In order to step through in configuration page with parameter numbers displayed, press “[*]” and “[<]” keys simultaneously.

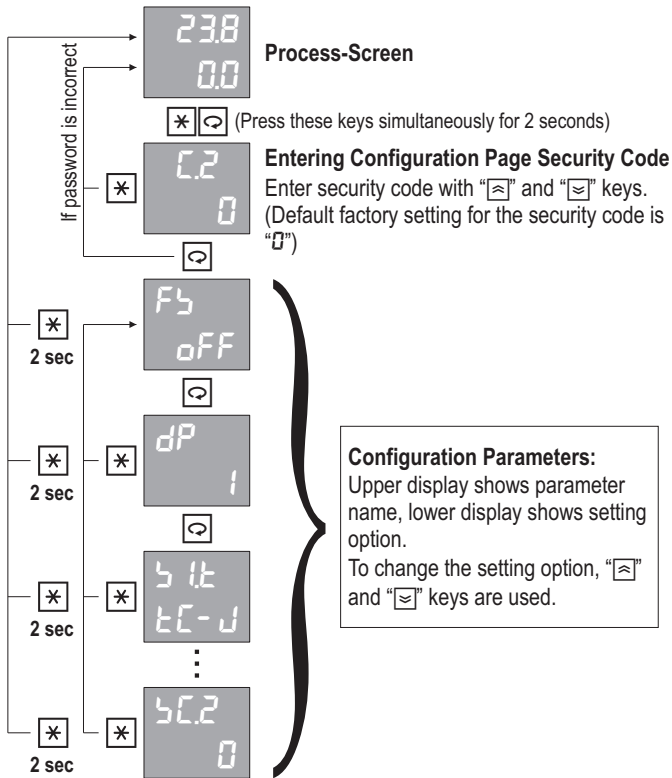



Figure-3

Detailed information about configuration page parameters can be found in the next section.

Par. 01  In order to restore the settings to the factory default, this parameter should be set to "on" and "☐" key should be pressed for two seconds.
 Setting Preferences: OFF, on

Par. 02  It determines the decimal level (number of digits after dot) of all parameters which have a unit of "EU".
 Setting Range : 0 - 3

Warning: When this parameter has been changed, all parameters which have a unit of "EU" should be set again.

Note: "EU", which is determined by "HU" parameter is a temperature unit for thermocouple or resistance thermometer measurements. Otherwise, it is an engineering unit that represents the measured variable.

Par. 03  "S1" determines the sensor type which is connected to the universal sensor input. This sensor is used to measure the process value.
 Setting Preferences: Table-1

Table-1	No	Sensor Type
tC-b	0	Type-B Thermocouple (Pt%18Rh-Pt)
tC-E	1	Type-E Thermocouple (Cr-Const)
tC-J	2	Type-J Thermocouple (Fe-Const)
tC-K	3	Type-K Thermocouple (NiCr-Ni)
tC-L	4	Type-L Thermocouple (Fe-Const)
tC-n	5	Type-N Thermocouple (Nicrosil-Nisil)
tC-r	6	Type-R Thermocouple (Pt%13Rh-Pt)
tC-S	7	Type-S Thermocouple (Pt%10Rh-Pt)
tC-t	8	Type-T Thermocouple (Cu-Const)
tC-U	9	Type-U Thermocouple (Cu-Const)
r t	10	Pt-100 Resistance Thermometer
0-50	11	0-50mV
0-20	12	0-20mA
4-20	13	4-20mA
0-10	14	0-10V
2-10	15	2-10V

Par. 04	<div style="border: 1px solid black; padding: 5px; background-color: #cccccc;"> 5 1LL 00 </div>	It determines the lower scale value of "S1" universal sensor input module.		
		<table style="width: 100%; border-collapse: collapse;"> <tr> <td style="width: 70%; border-right: 1px solid black; padding: 2px;"><i>Setting Range</i> : -999.9 - 999.9</td> <td style="padding: 2px;"><i>Unit</i> : EU</td> </tr> </table>	<i>Setting Range</i> : -999.9 - 999.9	<i>Unit</i> : EU
<i>Setting Range</i> : -999.9 - 999.9	<i>Unit</i> : EU			

Par. 05	<div style="border: 1px solid black; padding: 5px; background-color: #cccccc;"> 5 1HL 8000 </div>	It determines the higher scale value of "S1" universal sensor input module.		
		<table style="width: 100%; border-collapse: collapse;"> <tr> <td style="width: 70%; border-right: 1px solid black; padding: 2px;"><i>Setting Range</i> : -999.9 - 999.9</td> <td style="padding: 2px;"><i>Unit</i> : EU</td> </tr> </table>	<i>Setting Range</i> : -999.9 - 999.9	<i>Unit</i> : EU
<i>Setting Range</i> : -999.9 - 999.9	<i>Unit</i> : EU			

Par. 06	<div style="border: 1px solid black; padding: 5px; background-color: #cccccc;"> 5 1bL H </div>	It determines the value which scala will be set to when the universal sensor input connection is broken.
		<i>Setting Preferences</i> : L (Low value) , H (High value)

Par. 07	<div style="border: 1px solid black; padding: 5px; background-color: #cccccc;"> 5 2F oFF </div>	It determines the function of "S2" auxiliary analog input module.
		<i>Setting Preferences</i> : Table-2

Table-2	No	Analog Input Function
oFF	0	N/A
RP _U	1	Measured value is added to process value.
SP _U	2	Measured value is subtracted from process value.
PFb	3	It is used to get the valve position.
rSP	4	It is used to determine the set point remotely.

Par. 08	<div style="border: 1px solid black; padding: 5px; background-color: #cccccc;"> 5 2t 4-20 </div>	It determines the signal type that is connected to "S2" auxiliary analog input.
		<i>Setting Preferences</i> : 0- 20 (0-20mA) , 4- 20 (4-20mA)

Par. 09	<div style="border: 1px solid black; padding: 5px; background-color: #cccccc;"> 5 2LL 00 </div>	It determines the scale lower limit of "S2" auxiliary analog input module.		
		<table style="width: 100%; border-collapse: collapse;"> <tr> <td style="width: 70%; border-right: 1px solid black; padding: 2px;"><i>Setting Range</i> : -999.9 - 999.9</td> <td style="padding: 2px;"><i>Unit</i> : EU</td> </tr> </table>	<i>Setting Range</i> : -999.9 - 999.9	<i>Unit</i> : EU
<i>Setting Range</i> : -999.9 - 999.9	<i>Unit</i> : EU			

Par. 10	<div style="border: 1px solid black; padding: 5px; background-color: #cccccc;"> 5 2HL 8000 </div>	It determines the scale higher limit of "S2" auxiliary analog input module.		
		<table style="width: 100%; border-collapse: collapse;"> <tr> <td style="width: 70%; border-right: 1px solid black; padding: 2px;"><i>Setting Range</i> : -999.9 - 999.9</td> <td style="padding: 2px;"><i>Unit</i> : EU</td> </tr> </table>	<i>Setting Range</i> : -999.9 - 999.9	<i>Unit</i> : EU
<i>Setting Range</i> : -999.9 - 999.9	<i>Unit</i> : EU			

Par. 11	<div style="border: 1px solid black; padding: 5px; background-color: #cccccc;"> 5 2bL H </div>	If the signal that is connected to "S2" auxiliary analog input module cannot be received, then it determines the scale value.
		<i>Setting Preferences</i> : L (Low Value) , H (High Value)











Par. 12		<p>It determines the function of "S3" potentiometer input module.</p> <p><i>Setting Preferences</i> : Table-2</p>
Par. 13		<p>It determines the lower scale value of "S3" potentiometer input module.</p> <p><i>Setting Range</i> : -999.9 - 999.9 <i>Unit</i> : EU</p>
Par. 14		<p>It determines the higher scale value of "S3" potentiometer input module.</p> <p><i>Setting Range</i> : -999.9 - 999.9 <i>Unit</i> : EU</p>
Par. 15		<p>It determines scale value, when the potentiometer connected to "S3" potentiometer input module is broken.</p> <p><i>Setting Preferences</i> : L (Alt değer) , H (Üst değer)</p>
Par. 16		<p>It determines the temperature unit for the measurements of thermocouples or resistance thermometers.</p> <p><i>Setting Preferences</i> : °C (°C), °F (°F)</p>
Par. 17		<p>While measuring with thermocouples or resistance thermometers, in order to correct measurement errors, it is added to measured value.</p> <p><i>Setting Range</i> : -100.0 - 100.0 <i>Unit</i> : EU</p>
Par. 18		<p>It determines the time constant of digital filter that is applied to analog inputs. If this value is increased, reading stability increases but reading speed decreases.</p> <p><i>Setting Range</i> : 0.1 - 10.0 <i>Unit</i> : sec</p>
Par. 19		<p>It determines the function of "LU" logic input module.</p> <p><i>Setting Preferences</i> : Table-3</p>

Table-3	No	Logic Input Function
OFF	0	N/A
5P5	1	It is used to select the set point remotely.
rLÇ	2	Is it used to run programs remotely.

Par. 20  It determines the function of "O1" analog output module.

Setting Preferences : Table-4

Table-4	No	Analog Output Function
oFF	0	N/A
PCo	1	Positive directed PID control ouput.
nCo	2	Negative directed PID control ouput.
PuE	3	Process Transmitter
SPt	4	Set Point Transmitter

Par. 21  It determines the type of "O1" analog output module.

Setting Preferences : Table-5

Table-5	No	Analog Output Type
0-20	0	0-20mA
20-0	1	20-0mA
4-20	2	4-20mA
20-4	3	20-4mA
0-10	4	0-10V
10-0	5	10-0V
2-10	6	2-10V
10-2	7	10-2V

Note: In order to be able to use the first four preferences, this module should be identified as being "0/4-20mA" in product code. As for the last four preferences, "0/2-10V" should be used as identifying code.

Par. 22  It determines the lower value of output scale when "O1" analog ouput module is used as a transmitter.

Setting Range: -999.9 - 999.9 *Unit : EU*

Par. 23  It determines the upper value of output scale when "O1" analog ouput module is used as a transmitter.

Setting Range: -999.9 - 999.9 *Unit : EU*

Par. 24		It determines the function of "O2" analog output module. <i>Setting Preferences</i> : Table-4
Par. 25		It determines the type of "O1" analog output module. <i>Setting Preferences</i> : Table-5
Par. 26		If "O2" Analog output module is used as a transmitter, it determines the lower value of the output scale. <i>Setting Range</i> : -999.9 - 999.9 <i>Unit</i> : EU
Par. 27		If "O2" Analog output module is used as a transmitter, it determines the higher value of the output scale. <i>Setting Range</i> : -999.9 - 999.9 <i>Unit</i> : EU
Par. 28		It determines the function of "R1" relay output module. <i>Setting Preferences</i> : Table-6

Table-6	No	Relay Function	
oFF	0	N/A	
ULC	1	Upper Limit Control	ALARMS
LLC	2	Lower Limit Control	
ULR	3	Upper Limit Alarm	
LLR	4	Lower Limit Alarm	
UdR	5	Upper Deviation Alarm	

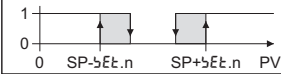
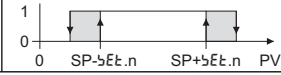
LdR	6	Lower Deviation Alarm	ALARMS	
obR	7	Outside Band Alarm		
ibR	8	Inside Band Alarm		
PCo	9	Positive directed PID control output		
nCo	10	Negative directed PID control output		
POF	11	Positive control output alert		
NOF	12	Negative control output alert		
oPn	13	Output of proportional valve opening		
CLC	14	Output of proportional valve closing		
$dBLC$	15	Control with serial communication		
rUn	16	Program run alert		
FnC	17	End of program alert		
StP	18	Step Alert		

Note: Hatched areas are hysteresis areas and hysteresis of each relay is determined with its "HYS.n" parameter. ("N" represents the relay number)

"1" in table means that related relay is powered on and "0" means powered off.

Par. 29



It determines the function of "R2" relay output module.

Setting Preferences : Table-6

Par. 30



It determines the function of "R3" relay output module.







Setting Preferences : Table-6

Par. 31

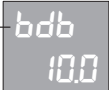



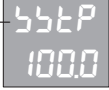



It determines the function of "R4" relay output module.

Setting Preferences : Table-6

Par. 32		It determines the function of bar indicator. <i>Setting Preferences: dEu</i> (Deviation from set value) <i>CoL</i> (Control Output Level)
Par. 33		If bar indicator indicates the deviation from set value, it determines the indicator band. <i>Setting Range : 0.1 - 999.9</i> <i>Unit : EU</i>
Par. 34		It determines the lower limit value of all set values. <i>Setting Range : -999.9 - [bPHL]</i> <i>Unit : EU</i>
Par. 35		It determines the upper limit value of all set values. <i>Setting Range : [bPLL] - 999.9</i> <i>Unit : EU</i>
Par. 36		The output until a certain set value during the cold system is used to block the arrival on the power of 10%. <i>Setting Range : on - off</i>
Par. 37		How many degrees when soft is active determined the set value to come out with 10% power. <i>Setting Range : 0 - 9999</i>
Par. 38		It determines the progress value per hours if user wants control set value progressed as a ramp. <i>Setting Range : off , 0.1 - 999.9</i> <i>Unit : EU</i>
Par. 39		It determines the number of steps belonging to a program in step control programs. <i>Setting Range : 1 - 100</i>

Warning: If this parameter is changed, previously coded programs may not be executed. So that, control your previously coded programs and if necessary, code them again.

Par. 40		Determines the number of step control programs.	
		Setting Range : 1 - 100	
		Warning : Multiplying the number of programs with the number of steps allocated to a program must not exceed 800.	
Par. 41		Determines the time unit in the step control program.	
		Setting Option : SEC (second) , min (minute) , Hr (hours)	
Par. 42		It determined the decimal point value of step control program's time variable.	
		Setting Range : 0 - 1	
Par. 43		It is used for the measured value to enter the approximation band of set value at the end of each step.	
		Setting Preferences : off(Off) , on(On)	
Par. 44		It determines the approximate band of control set value in step control programs.	
		Setting Range : 0.0 - 999.9	Unit : EU
Par. 45		It determines the duration of program ending alert after finishing the execution of step control program.	
		Setting Range : Cont (continuous) , 1 - 600	Unit : sec
Par. 46		It determines if system will be controlled or not with a constant set value while the step control program is not active.	
		Setting Preferences : off(No) , on(Yes)	













Par. 47		It determines how the program will continue to execute when a power cut happens. <i>Setting Preferences : Table-7</i>
---------	---	--

Table-7	No	Power Cut Action
Cnt	0	Program continues from the last location.
APr	1	Starts from "APr" status. (Last set value and time are made fixed, it continues from the last location when process value enters the approximate band of set value).
Hld	2	Starts from "Hld" status. (Last set value and time are made fixed, it continues from the last location when the "RUN" command is executed by operator)
PUs	3	Starts from "PUs" status. (Last set value and time are made fixed, control output is closed, it continues from the last location when the "RUN" command is executed by the operator)
R-P	4	Starts from "PUs" status. When "RUN" command is executed, control output becomes active and is set to "APr" status. It continues from the last point when process value enters the approximate band of set value.
H-P	5	Starts from "PUs" status. When "RUN" command is executed, control output becomes active and is set to "HOLD" status. It continues from the last point when "RUN" command is executed again.
brP	6	Program is terminated without executing it all.



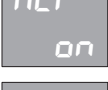

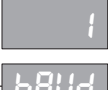
Par. 48		It determines the control form (direction). <i>Setting Option : dCr</i> (While process value is increasing, output increases too), <i>rEu</i> (While process value is increasing, output decreasing too)
---------	--	---

Par. 49		It determines the proportional band of positive directed PID control output. <i>Setting Range: oFF</i> (ON/OFF control) , <i>0.1 - 999.9</i> <i>Unit : EU</i>
---------	---	--

Par. 50	<div style="background-color: #cccccc; padding: 5px; border: 1px solid black;"> noPb oFF </div>	It determines the proportional band of negative directed PID control output. Setting Range: oFF (ON/OFF control) , 0.1 - 999.9 Unit : EU
Par. 51	<div style="background-color: #cccccc; padding: 5px; border: 1px solid black;"> tI oFF </div>	Integral time constant. Setting Range : oFF (Closed) , 1 - 6000 Unit : sec
Par. 52	<div style="background-color: #cccccc; padding: 5px; border: 1px solid black;"> dI oFF </div>	Differrantial time constant. Setting Range : oFF (Closed) , 0.1 - 999.9 Unit : sec
Par. 53	<div style="background-color: #cccccc; padding: 5px; border: 1px solid black;"> CP 2.0 </div>	It determines the period of a control cycle. Setting Range : 0.1 - 60.0 Unit : sec Note: In order to prevent from oscillations caused from control period, control period should be selected minimum to system dead time.
Par. 54	<div style="background-color: #cccccc; padding: 5px; border: 1px solid black;"> CoLL -100.0 </div>	It determines the lower limit of PID control output. Setting Range : -100.0 - [CoHL] Unit : %
Par. 55	<div style="background-color: #cccccc; padding: 5px; border: 1px solid black;"> CoHL 100.0 </div>	It determines the higher limit of PID control output. Setting Range : [CoLL] - 100.0 Unit : %
Par. 56	<div style="background-color: #cccccc; padding: 5px; border: 1px solid black;"> CoBt 0.0 </div>	It determines the initial value of PID control output. (When integral is closed, it is the control output value which process value and set value are equal) Setting Range : -100.0 - 100.0 Unit : %
Par. 57	<div style="background-color: #cccccc; padding: 5px; border: 1px solid black;"> CoDb 0.1 </div>	While using double sided PID control, it determines the dead band of control output while changing direction. Setting Range : 0.1 - 25.0 Unit : %
Par. 58	<div style="background-color: #cccccc; padding: 5px; border: 1px solid black;"> uTt 100 </div>	Time period to enter from closed position to open position for non feed back proportional valve (This periode should be measured) Setting Range : 10 - 2500 Unit : sn

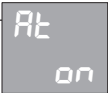
Par. 59		<p>It determines the dead band of proportional valve. If this value is increased, valve movement becomes stable but sensitivity decreases.</p> <p><i>Setting Range : 0.1 - 25.0</i> <i>Unit : %</i></p>
Par. 60		<p>Lower callibration of potentiometer that is connected to "S3". While this parameter is shown, potentiometer should be brought to lowest position and this position should be saved by pressing and holding the "[]" key for 2 seconds.</p>
Par. 61		<p>Higher callibration of potentiometer that is connected to "S3". While this parameter is shown, potentiometer should be brought to highest position and this position should be saved by pressing and holding the "[]" key for 2 seconds.</p>
Par. 62		<p>It determines the control type for Auto-Tune operation.</p> <p><i>Setting Preferences : P, P\bar{I}, P\bar{I}d (P, PI, PID)</i></p>
Par. 63		<p>It allows the control periode is calculated automatically by Auto-Tune operation.</p> <p><i>Setting Preferences: aFF(No) , on(Yes)</i></p>
Par. 64		<p>If user wants the Auto-Tune operation to make for a certain set value, it determines this set value.</p> <p><i>Setting Range : aFF(Closed) , 199.9 - 999.9</i> <i>Unit : EU</i></p>
Par. 65		<p>Hysteresis value for Auto-Tune operation. It should be set to 5-20 times of system instability.</p> <p><i>Setting Range : 0.1 - 100.0</i> <i>Unit : EU</i></p>
Par. 66		<p>It determines the serial communication address. All addresses should be unique that are connected to a serial communication line.</p> <p><i>Setting Range : aFF(Closed) , 1 - 255</i> <i>Unit : EU</i></p>
Par. 67		<p>It determines the serial connection speed.</p> <p><i>Setting Preferences : 9.6 , 19.2 , 38.4</i> <i>Unit : Kbps</i></p>

Par. 68		<p>It determines the parity type in serial communication.</p> <p><i>Setting Preferences :</i> none(None) , odd(Odd) , Evn(Even)</p>
Par. 69		<p>It is the permission of number of step control program that operator can change it or not.</p> <p><i>Setting Preferences:</i> off(Off) , on(On)</p>
Par. 70		<p>Permission for operator that repetition number of step control program can be changed or not.</p> <p><i>Setting Preferences:</i> off(Off) , on(On)</p>
Par. 71		<p>Permission for changing the control set value by the operator.</p> <p><i>Setting Preferences:</i> off(Off) , on(On)</p>
Par. 72		<p>Permission for changing the "LEN" set value that belongs to relays.</p> <p><i>Setting Preferences:</i> off(Off) , on(On)</p>
Par. 73		<p>Permission for changing the hysteresis ("HYB") value by the operator.</p> <p><i>Setting Preferences:</i> off(Off) , on(On)</p>
Par. 74		<p>Permission for changing the mode to Manual-Control.</p> <p><i>Setting Preferences:</i> off(Off) , on(On)</p>
Par. 75		<p>Permission for changing the mode to Automatic-Control.</p> <p><i>Setting Preferences:</i> off(Off) , on(On)</p>
Par. 76		<p>Permission for changing the mode to Program-Control</p> <p><i>Setting Preferences:</i> off(Off) , on(On)</p>

Par. 77		It is the permission to change the mode to manual pause.	
		Setting Preferences: OFF (Off) , ON (On)	
Par. 78		Permission for starting the Auto-Tune operation.	
		Setting Preferences: OFF (Off) , ON (On)	
Par. 79		It determines the "CoL" parameter is shown or not which represents the PID control output level in operator page.	
		Setting Preferences: OFF (Off) , ON (On)	
Par. 80		While in operator parameters, it determines the automatic return time to Process-Screen.	
		Setting Range : OFF (Off) , 1 - 25	Unit : sec
Par. 81		It determines the security code for Program page.	
		Setting Range : 1999 - 9999	
Par. 82		It determines the security code for Configuration page.	
		Setting Range : 1999 - 9999	

Time oriented programs can be written for processes that will be controlled for PC991 devices as explained below. These programs include steps that determines the change of set value dependent on the time. "Time" and "target set value" are determined for each step. Also the the position of relays which are selected as alarm are determined. In these programs set value is initialized with process value firstly and it finalized with the value which is determined with "b5P" parameter in configuration page.

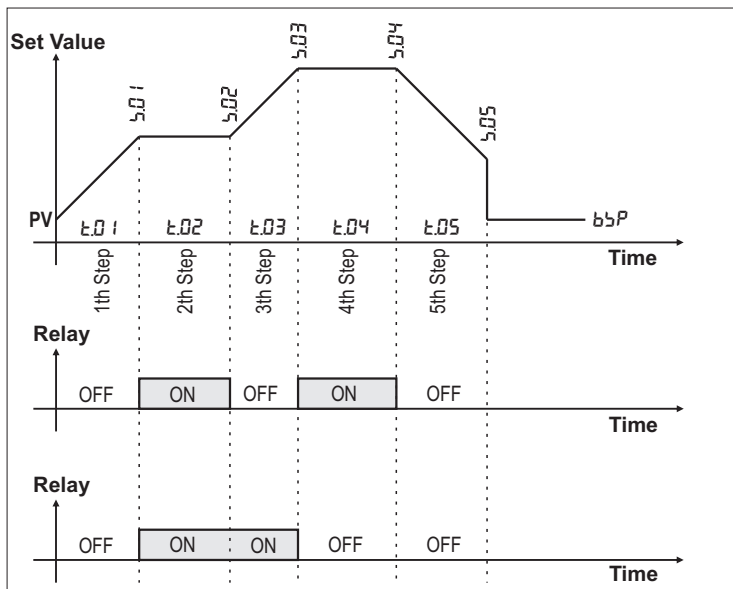

Before starting to code the programs, the function of relays which will be used as "step alert" should be selected as being "55P".

In addition to this, number of steps for a program and the maximum number of programs should be selected by using the "n5" and "nP" parameters. These devices have a memory of program that will have a maximum step number of 800. So, multiplication of "n5" and "nP" parameters should not exceed 800.

In order to create a program, user should enter the program page as being shown in Figure-4 and program number should be selected. By pressing the "" key, parameters that belongs to program's step can be accessed and set. In order to determine the end of program, duration of the last step is selected as being "End" and by pressing the "" key and holding it for 2 seconds, Process Screen is to be returned.

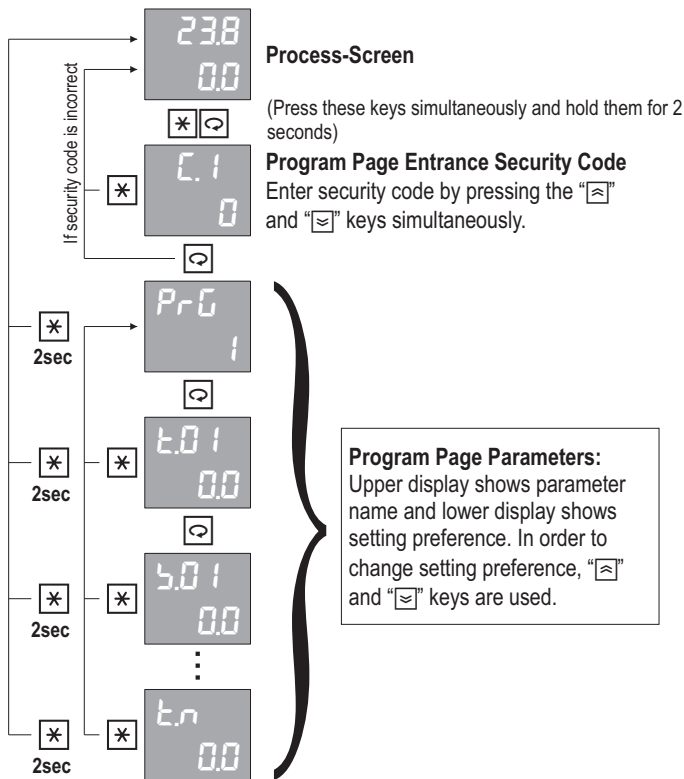



Figure-4

Detailed information about program page parameters can be found in the next section.

	Program number.	
	Setting Range : 1 - [noP]	





	Period of 1th step	
	Setting Preferences : Table-8 , 0.0 - 360.0	Unit : [tU]

Table-8	No	Explanation
<i>RP_r</i>	-1	In this step, control set value and target set value are made fixed. When the process value enters approximated band of set value, next step starts to execute. During this step, "RPPr" message flashes in Process Screen.
<i>HL_d</i>	-2	In this step, control set value and target set value are made fixed. When the "RUN" command is executed by operator, next step starts to execute. During this step, "HLd" message flashes in Process Screen.
<i>End</i>	-3	It determines the end of program. Step time should be selected as being "End" on the last step of each

	Target set value of 1th step.	
	Setting Range : [tPLL] - [tPHL]	Unit : EU

	It determines the "R1"s position in the 1th step. In order to make this parameter visible, "r1F" parameter should be selected as being "tEP".	
	Setting Preferences : off(Not Energized) , on(Energized)	

	It determines the "R2"s position in the 1th step. In order to make this parameter visible, "r2F" parameter should be selected as being "tEP".	
	Setting Preferences : off(Not Energized) , on(Energized)	

	It determines the "R3"s position in the 1th step. In order to make this parameter visible, "r3F" parameter should be selected as being "tEP".	
	Setting Preferences : off(Not Energized) , on(Energized)	

d.01 off	It determines the "R4"s position in the 1th step. In order to make this parameter visible, "r 4F" parameter should be selected as being "bEP". Setting Preferences : oFF (Not Energized) , oN (Energized)
t.02 00	Period of 2th step. Setting Preferences : (Table-8) , 00 - 3600 Unit : [tU]
s.02 00	Target set value of 2th step. Setting Range : [bPLL] - [bPHL] Unit : EU
R.02 off	It determines the "R1"s position in the 2th step. In order to make this parameter visible, "r 1F" parameter should be selected as being "bEP". Setting Preferences : oFF (Not Energized) , oN (Energized)
b.02 off	It determines the "R2"s position in the 2th step. In order to make this parameter visible, "r 2F" parameter should be selected as being "bEP". Setting Preferences : oFF (Not Energized) , oN (Energized)
c.02 off	It determines the "R3"s position in the 2th step. In order to make this parameter visible, "r 3F" parameter should be selected as being "bEP". Setting Preferences : oFF (Not Energized) , oN (Energized)
d.02 off	It determines the "R4"s position in the 2th step. In order to make this parameter visible, "r 4F" parameter should be selected as being "bEP". Setting Preferences : oFF (Not Energized) , oN (Energized)
⋮	⋮
t.n End	Period of nth step. Setting Preferences : (Table-8) , 00 - 3600 Unit : [tU] Warning: The value which is represented by "n" is the number of last step. Duration of this step should be determined as being "End".

Existing configuration determines which parameters will be used in operator page and only necessary parameters are displayed. These parameters which are determined in configuration are used in normal operation conditions. So, While in Process Screen, by pressing key " \square " key, user can access these parameters in any time and by pressing the " $*$ " key, user returns to Process-Screen again. Setting permission of the changeable parameters can be set with the related parameters in configuration page. While in any parameter in operator page, if user does not press any key, Process-Level is to be returned after the time which is determined by "RrL" parameter, pass.

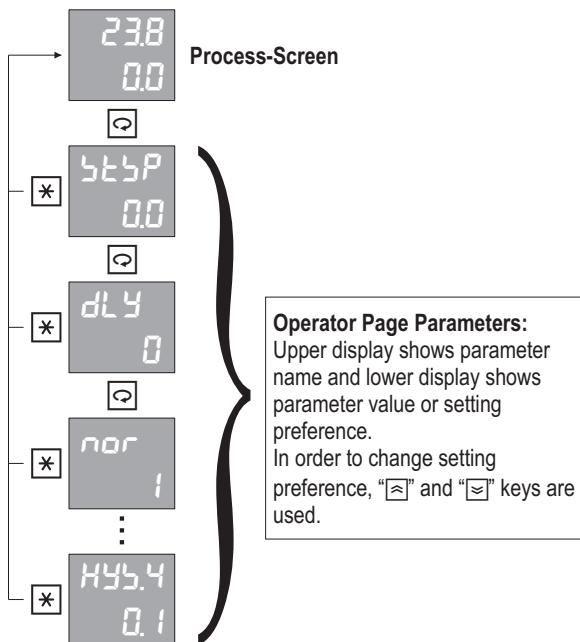

Detailed information about operator page parameters can be found in the next section.

<p>Pu1 00</p>	<p>It displays the data incoming from "S1" universal sensor input. In order to make this parameter visible, "S2F" or "S3F" parameters should be selected as "RPu" or "SPu".</p> <p style="text-align: right;">Unit : EU</p>
<p>Pu2 00</p>	<p>It displays the data incoming from "S2" auxiliary analog input. In order to make this parameter visible, "S2F" parameter should be selected as "RPu" or "SPu".</p> <p style="text-align: right;">Unit : EU</p>
<p>Pu3 00</p>	<p>It displays the data incoming from "S3" potentiometer input. In order to make this parameter visible, "S3F" parameter should be selected as "RPu" or "SPu".</p> <p style="text-align: right;">Unit : EU</p>
<p>SuSP 00</p>	<p>Constant value while the program is not active. Control is done using this value at these spare times between program operations.</p> <p>Setting Range : [SuPLL] - [SuPHL]</p> <p style="text-align: right;">Unit : EU</p>
<p>dLY 0</p>	<p>It determines the delay time before program operation. With the use of RUN command, this delay duration starts and step number is seen as 00. Program starts to execute after this duration finishes.</p> <p style="text-align: right;">Unit : [EU]</p>
<p>nor 1</p>	<p>Program should be setted to requested repetition number before the execution. While program is running, it displays the remaining repetition number.</p> <p>Setting Range : CNT (Continuous Repetition) , 1 - 250</p>
<p>rSt 0.1</p>	<p>It displays the remaining step time.</p> <p style="text-align: right;">Unit : [EU]</p>
<p>PSP 00</p>	<p>It shows the instantaneous set value.</p> <p style="text-align: right;">Unit : EU</p>
<p>CoL 00</p>	<p>It displays the level of PID control output. In order to make this parameter visible, "CoP" parameter which is in configuration page should be selected as being "on".</p> <p style="text-align: right;">Unit : %</p>

<p>PVP 0.0</p>	<p>It shows the position of proportional valve. In order to make this parameter visible, "52F" or "53F" parameters should be selected as being "PFb" in configuration page.</p> <p style="text-align: right;">Unit : %</p>
<p>55P.1 0.0</p>	<p>It determines the 1th optional set value. In order to make this parameter visible, "LUF" parameter should be selected as being "5P5".</p> <p>Setting Range : [5PLL] - [5PHL]</p> <p style="text-align: right;">Unit : EU</p>
<p>⋮</p>	<p>⋮</p>
<p>55P.8 0.0</p>	<p>It determines the 8th optional set value. In order to make this parameter visible, "LUF" parameter should be selected as being "5P5".</p> <p>Setting Range : [5PLL] - [5PHL]</p> <p style="text-align: right;">Unit : EU</p>
<p>5Et.1 0.0</p>	<p>It determines the set value of "R1" module. In order to make this parameter visible, "r tF" parameter should be selected as ALARM.</p> <p>Setting Range : [5PLL] - [5PHL]</p> <p style="text-align: right;">Unit : EU</p>
<p>⋮</p>	<p>⋮</p>
<p>5Et.4 0.0</p>	<p>It determines the set value of "R4" module. In order to make this parameter visible, "r 4F" parameter should be selected as ALARM.</p> <p>Setting Range : [5PLL] - [5PHL]</p> <p style="text-align: right;">Unit : EU</p>
<p>HYS 0.1</p>	<p>It determines the control hysteresis value. In order to make this parameter visible, one of the proportional band should be selected as being "oFF".</p> <p>Setting Range : 0.1 - 100.0</p> <p style="text-align: right;">Unit : EU</p>
<p>HYS.1 0.1</p>	<p>It determines the hysteresis value of "R1" module. In order to make this parameter visible, "r tF" parameter should be selected as being ALARM.</p> <p>Setting Range : LLE(Locked) , 0.1 - 100.0</p> <p style="text-align: right;">Unit : EU</p>
<p>⋮</p>	<p>⋮</p>
<p>HYS.4 0.1</p>	<p>It determines the hysteresis value of "R4" module. In order to make this parameter visible, "r 4F" parameter should be selected as being ALARM.</p> <p>Setting Range : LLE(Locked) , 0.1 - 100.0</p> <p style="text-align: right;">Unit : EU</p>

While configuring model PC991 devices, if PID parameters ($PoPb$, $noPb$, τ_t , dt , CP) are default factory parameters, control outputs operate in ON/OFF mode. In order to begin operating with PID parameters, these parameters should be determined manually or Auto-Tune operation should be done.

Because every process has different characteristics, PID parameters should be different too. Auto-Tune operation calculates the optimum PID parameters and saves them.

Before starting to operate Auto-Tune operation, " $RtSP$ " and " $RtHr$ " parameters should be set and " Rt " parameter should be " on ". If " $RtSP$ " parameter is " OFF ", Auto-Tune operates by using the set value at that time. In order to get the optimum PID parameters, selected set value should be at about the middle of process' whole power.

After having appropriate settings, while in Process-Screen, press the " \square " key for 5 seconds to start the Auto-Tune operation then " Rt " message flashes in "ST" display. In order to have correct results, nobody should interfere with the system. While in Auto-Tune operation, the device calculates and saves new PID parameters after doing ON/OFF control for 2 or 3 oscillations with the determined set value and hysteresis. After finishing the Auto-Tune operation, " Rt " message in display disappears and the device begins to control the system (process) using the new PID parameters. After finishing the Auto-Tune operation, " Rt " parameter in configuration page should be changed to " OFF " state again. While in the Auto-Tune state, pressing the " \times " key cancels the operation.

If user wants a device to operate in ON/OFF mode instead of PID, PID parameters should be set to default factory output.

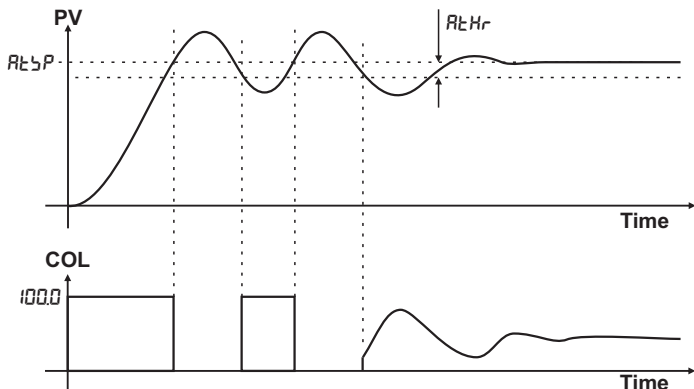

Model PC991 devices can operate in three different modes. These are Automatic-Control mode, Manual-Control mode and Program-Control mode. While in Process-Screen, by pressing the “*” key for 5 seconds, modes can be changed. The function of “ST” display in Process-Screen is changes as explained below.

Unintended operating mode can be closed by using “RL”, “nL” and “PL” parameters in configuration page. While changing the operation mode, closed modes are skipped.

AUTOMATIC CONTROL MODE : Control is done according to the selected set value.

Process Value		<input type="radio"/> R1
		<input type="radio"/> R2
		<input type="radio"/> R3
Set Value		<input type="radio"/> R4
		<input type="radio"/> MN
		<input type="radio"/> SN

In this mode, “MN” and “SN” leds do not indicate.
Set value is selected by using “↔” and “⇄” keys.

*** 5sec**

MANUAL CONTROL MODE : Control output level is determined as manual.

Process Value		<input type="radio"/> R1
		<input type="radio"/> R2
		<input type="radio"/> R3
Output Level		<input checked="" type="radio"/> R4
		<input checked="" type="radio"/> MN
		<input type="radio"/> SN

In this mode, “MN” led indicates.
Output level is determined by using “↔” and “⇄” keys.

*** 5sec**

PROGRAM CONTROL MODE : Control is done according to the selected program.

Process Value		<input type="radio"/> R1
		<input type="radio"/> R2
		<input type="radio"/> R3
Program Number		<input type="radio"/> R4
		<input checked="" type="radio"/> MN
		<input checked="" type="radio"/> SN

In this mode, “SN” led indicates. Program number that is the identity of running program is selected by using “↔” and “⇄” keys. By pressing the “*” and “↔” keys simultaneously, it is started to execute, by pressing the “*” ve “⇄” keys simultaneously, it is stopped.

*** 5sec**

Determination of remote set point can be done in three different methods while using model PC991 devices. These methods are described separately below:

Determining Set Point by Using Auxiliary Analog Input (Remote Set Point):

"**٥٢F**" parameter that can be accessed in configuration page should be selected as being "**ر٥P**" and by using the "**٥٢١١**", "**٥٢H١**" parameters, a scale value should be selected.

Determining Set Point by Using Potentiometer Input (Remote Set Point):

"**٥٣F**" parameter that can be accessed in configuration page should be selected as being "**ر٥P**" and by using the "**٥٣١١**", "**٥٣H١**" parameters, a scale value should be selected. Also lower and higher position of potentiometer should be saved by using "**٥٣١٢**" and "**٥٣H٢**" parameters.

Determining Set Point by Using Logic Input Module :

There are 3 logic input in "LU" input module in these devices. These inputs are in P1,P2,P3 in order. If "**٤٤F**" parameter which can be accessed from configuration page is selected as "**٥٥P١**", then 8 set values are shown as being "**٥٥P.١-٥٥P.٨**" in operator page. These are optional set values and according to signal that is received from P1,P2,P3 inputs, by using the table below they are selected as control set values. In automatic mode, selected set value is displayed in ST display and is used as control set value.

If optional set values and remote set value are used in to gether, remote set value is added to 1th optional set point.

P1	P2	P3	Code	Explanation
0	0	0	٥٥P.١	1th Optional Set Value
1	0	0	٥٥P.٢	2th Optional Set Value
0	1	0	٥٥P.٣	3th Optional Set Value
1	1	0	٥٥P.٤	4th Optional Set Value
0	0	1	٥٥P.٥	5th Optional Set Value
1	0	1	٥٥P.٦	6th Optional Set Value
0	1	1	٥٥P.٧	7th Optional Set Value
1	1	1	٥٥P.٨	8th Optional Set Value

Note: "1"s in table states that the input is energized and "0"s states that input is not energized. Inputs are energized by connecting the VS+ point to the related input.

Model PC991 devices controls motorized valves in two way. One of them is control with feedback and the other is control without feedback. Proportional motorized valve control without feedback is also called as floating-control.

In order to be able to control motorized valve, one of the relays of device should be used to move the valve in the open direction and the function of this relay should be selected as being "OPN". Other relay should be used to move the valve in the close direction and the function of this relay should be "CLS".

If the valve has potentiometer for nonfeedback operations, this potentiometer should be connected to "S3" input and "3F" parameter should be selected as being "PFb". Also lower and higher values of this potentiometer should be saved by using "3LL" and "3HL" parameters. If two relays are selected open and close the valve and the system is ready to run, while these parameters are shown in screen, user can control the motor manually by using "↔" and "⇄" keys.

If "3F" parameter is not selected as being "PFb", valve is controlled without feedback(floating-control).

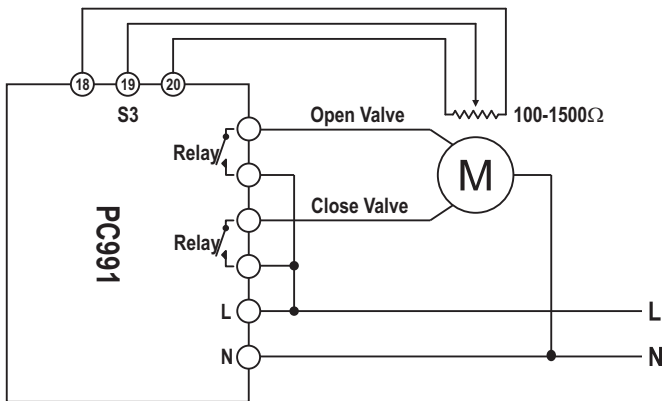

In order to be able to control the proportional valve without feedback, the time pass should be measured from the open position to the close position and it should be entered into the "ULt" parameter in configuration page.

Motor position is controlled with PID output. So, PID parameters must be determined. If PID parameters are not determined manually, in order to let the device determine the parameters automatically, Auto-Tune operation should be done.









Proportional Motorized Valve Control

In order to run a program in model PC991, “” key should be pressed for 5 seconds, so that Program-Control mode will activate.







While in this mode, SN led indicates and PV display shows the measured process value, first two digit of ST display shows the number of last selected program. Number of program that will be executed is selected by pressing “” and “” keys. By using the RUN command, program starts to execute.

Commands that are activated by keys:

RUN Command : On condition that “” key is pressed firstly, “” and “” keys are pressed simultaneously.

STOP Command : On condition that “” key is pressed firstly, “” and “” keys are pressed simultaneously.

Commands that are entered by using logic inputs: In order to run a program remotely with the commands that are entered from logic inputs, “*LUF*” parameter should be selected as being “*rLE*” in configuration page. These explanation of these commands may be found below:

P1		RUN		STOP
P2		PAUSE		Continue
P3		HOLD		Continue

While the program is executing, first two digit of ST display shows the number of program executing and last two digit of display shows the step number and SN led blinks for a period of 1sec.

If the time of running step is selected as “*RP r*” vey a “*HL d*”, during the period of this step, “*RP r*” vey a “*HL d*” message flashes in ST display.

While executing program, in order to access the next step immediately RUN command is used. To stop program immediately, STOP command should be used.

If “*PE*” parameter in configuration page is selected as being “*on*”, first STOP command makes the program enter in PAUSE condition and ST display flushes with “*PAUSE*” message.

While PAUSE is active, all control outputs are closed, time and set value are made fixed. If RUN command is used within this condition, program executes from the last point. If STOP command is used, program is terminated completely.

While the program is executing, operator parameters can be viewed by pressing the “” key.

Furthermore, while program is executing, set value and control output can be changed manually by changing the operation mode.

If user returns the Program-Control mode again, program continues to execute from the last point.

While the program is executing, relays that are selected as step alert and programmed by, are powered on when the appropriate step becomes current.

When the program has finished execution, the relay which is defined as program end alert is energized and stays in this condition for a time which is determined by "FRt" parameter.

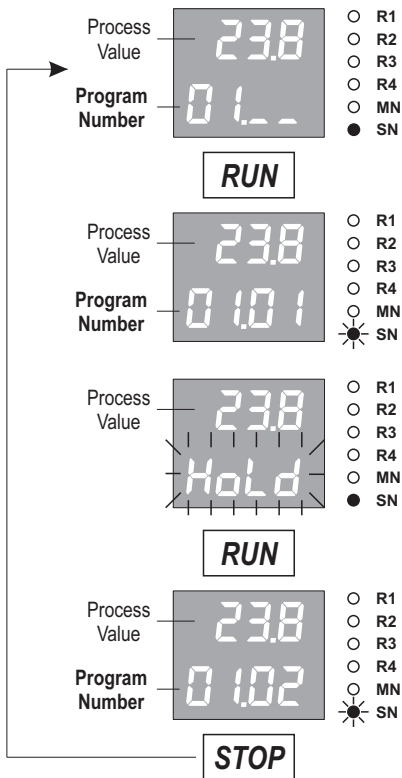

This devices are designed to be communicated in slave mode with MODBUS RTU protocol. All parameters and registers can be accessed with this communication type. Parameters can be read or can be set to a value.

Serial communication is established with Half-Duplex RS485 line. 32 devices can be connected to one RS485 line.

The cable which is used in communication line should be a data cable that is compatible with Half-Duplex RS485 communication and this cable should be connected parallel to all devices as a single line. Both cable ends should be terminated with a appropriate resistance. A communication line which is appropriate for 9600 Bps data transmission speed can be up to 1000m.

Each device on serial communication line should have an unique address between 1 and 255 but all devices in this line should have same speed and parity type. Communication address, speed and parity type of these devices are determined with " *Addr*, *bAUD* ve *Prty*" parameters which are in configuration page.

Below, you can find information about functions which are supported by MODBUS RTU, parameter addresses and others in tables.

Supported Standard MODBUS RTU Functions:

Function 01 = Read Coils

Function 03 = Read Holding Registers

Function 05 = Write Single Coil

Function 06 = Write Single Register

Function 16 = Write Multiple Registers

BIT Type Parameters (COILS)

Address	Explanation (1 / 0)	Set Perm.
0	Auto-Tune (ON / OFF)	
1	"R1" relay module (ON / OFF)	
2	"R2" relay module (ON / OFF)	
3	"R3" relay module (ON / OFF)	
4	"R4" relay module (ON / OFF)	
5	ERR1 Error (Yes / No)	No
6	ERR2 Error (Yes / No)	No
7	ERR3 Error (Yes / No)	No
8	General Error (Yes / No)	No
9	(RUN / STOP)	
10	PAUSE (Yes / No)	
11	HOLD (Yes / No)	
12	APPR (Yes / No)	No
13	FNS (Yes / No)	No

REGISTER Type Parameters (REGISTERS)

Adres	Explanation	Setting Range		Mul.	Unit	Set Perm.
0	Valid decimal point	0	3	1		No
1	Measured process value	-1999	9999	10 ^{DP}	EU	No
2	Control set value	-1999	9999	10 ^{DP}	EU	
3	PID control output level	-1000	1000	10	%	
4	Operating mode	0	2	1		
5	Measured process value from 1. sensor	-1999	9999	10 ^{DP}	EU	No
6	Measured process value from 2. sensor	-1999	9999	10 ^{DP}	EU	No
7	Measured process value from 3. sensor	-1999	9999	10 ^{DP}	EU	No
8	Instantaneous set value	-1999	9999	10 ^{DP}	EU	No
9	Valve movement direction	0	2	1		No
10	Valve location	0	1000	10	%	No
11	Program number	1	100	1		
12	Control set value out of program	-1999	9999	10 ^{DP}	EU	
13	Program delay time	0	3600	10 ^{TDP}	TU	
14	Setted repetition count	0	250	1		
15	Remaining repetition count	0	250	1		No
16	Operating step number	0	100	1		No
17	Duration to end of step	0	3600	10 ^{TDP}	TU	No

Addr.	Explanation	Setting Range		Mul.	Unit.	Set Perm.
20	1.Optional set point	-1999	9999	10 [^] DP	EU	
21	2.Optional set point	-1999	9999	10 [^] DP	EU	
22	3.Optional set point	-1999	9999	10 [^] DP	EU	
23	4.Optional set point	-1999	9999	10 [^] DP	EU	
24	5.Optional set point	-1999	9999	10 [^] DP	EU	
25	6.Optional set point	-1999	9999	10 [^] DP	EU	
26	7.Optional set point	-1999	9999	10 [^] DP	EU	
27	8.Optional set point	-1999	9999	10 [^] DP	EU	
28	Set value of "R1" module	-1999	9999	10 [^] DP	EU	
29	Set value of "R2" module	-1999	9999	10 [^] DP	EU	
30	Set value of "R3" module	-1999	9999	10 [^] DP	EU	
31	Set value of "R4" module	-1999	9999	10 [^] DP	EU	
32	Control hysteresis value	1	1000	10 [^] DP	EU	
33	Hysteresis value of "R1" module	0	1000	10 [^] DP	EU	
34	Hysteresis value of "R2" module	0	1000	10 [^] DP	EU	
35	Hysteresis value of "R3" module	0	1000	10 [^] DP	EU	
36	Hysteresis value of "R4" module	0	1000	10 [^] DP	EU	

Note: Please contact to producer firm for the communication information about other parameters

Before start to use the device, be sure these steps are done.

- Be sure that **S1** parameter is chosen suitable with the sensor type you want to use. (S1 Universal sensor input is in the page 15 table - 1)
- Be sure **S1L** parameter is set to lowest value by sensor scale of S1
- Be sure **S1H** parameter is set to highest value by sensor scale of S1
- Be sure **r1F,r2F,r3F,r4F** parameters are chosen suitable with the function of relay. (Relay output number is optional. It can be change by device model. Relay function table is in the page 19 and 20 table - 6)
- Be sure **a1F** parameter is set to suitable function of analog output you want to use. (Analog output number is optional. It can be change by device model. Analog output functions table is in the page 18 table - 4)
- Be sure **a1L** parameter is chosen suitable with the current/voltage output type shown on the device label (Analog output number is optional. It can be change by device model. Analog output type table is in the page 18 table - 5)
- Be sure **a1L** parameter is set to lowest value of analog output scale you want to use.(Analog output number is optional. It can be change by device model)
- Be sure **a1H** parameter is set to highest value of analog output scale you want to use.(Analog output number is optional. It can be change by device model)

To make PID Control :

- If you want to use Relay Output Module, be sure:

r1F,r2F,r3F,r4F parameters (the ones you want use in PID control) should set to suitable functions between **PID,ON,POF,NOF,OPN,CLL,dLL** options that chosen from relay functions table

- If you want to use Analog Output Module, be sure:

a1F parameter is set to proper function between **PID,ON** options that chosen from analog output function table.

To make PID control with your device, you can enter parameters manually or automatically.

If you know the characterise of system, you can enter manually these parameters:

- Proportional band value of positive PID control output P_{oPb} , Proportional band value of negative PID control output n_{oPb} , Integral time constant $\int t$, Differential time constant $d t$, and Control period sampling time ζP .

You can start Auto-Tune function and device will calculate PID control parameters automatically.

To start Auto-Tune process :

- Enter temperature value of process set point to $RtSp$ parameter. This value should be around mid points of process' full power .
- Enter hysteresis value of process set point to $RtHr$ parameter. This value arranges the sensitivity of Auto-Tune process.
- Set Rt parameter on .

When the device main screen, press "" button for 5 seconds.

While Auto-Tune operation is working, device display shows blinking Rt . This expression fades away when the Auto-Tune process is finished.

To cancel the Auto-Tune operation, press "" button while operation is running.

www.ordel.com.tr

Üretici ve Teknik Servis : ORDEL Ltd. Şti. Uzayçağı Cad. 1252. Sok. No:12 OSTİM / ANKARA
Tel: +90 312 385 70 96 (PBX) Fax: +90 312 385 70 78

ORDEL