

OC440

Oven Controller USER'S GUIDE



ORDEL



- Before using the device, please read the warnings below and this guide carefully. The accidents or damages resulting from not following the warnings included in this guide are under user's responsibility.
- This device is intended to be used by qualified personnel in industrial environments, do not use in houselike environments.
- Do not use the device at places where corrosive, flammable and explosive gases exist. Contact points may create electrical discharge and this may cause explosion or fire.
- Do not allow metal fragments or lead wire scraps or liquid matters to fall inside this device. Otherwise fire or electrical shock may happen.
- Take the necessary precautions in order to prevent accidents and damages that may result in case the device gets faulty.
- There is no fuse or switch that brings the device in power down state, these should be added to the system by the user.
- Sensor and signalling cables should not be routed close to the power cables or inductive load cables.
- Do not power up the device before the connections related with the device are performed in accordance with connection diagram.
- Do not power up the device before the connections related with the device are performed in accordance with the connection diagram. While the device is powered, do

SECTION	Page:
Safety Precautions	2
Contents	3
Description of the Device	4
Preparations	5
Connection Diagram	6
Product Code	8
Technical Specifications	9
Temperature Sensor Types	10
Display and Key Functions	11
Configuration	13
Configuration Page Parameters	15
Operator Page	22
Operator Page Parameters	23
Auto-Tune Operation	24
Serial Communication	25
Configuration Guide	29

OC440 Model devices are designed for the applications which requires synchronous temperature control and timing. They are reliable, hi tech devices in dimension of 96x96mm and adapted to international standards.

They offer advanced (PID/ON/OFF) control, hi accuracy and stability, alternative hardware, all-purpose programming and easy use features.

They can be used with all kinds of power supply by the feature of Universal Power Supply.

They can connect MODBUS connection network via RS485 Communication Module. They can be controlled in network, send and receive data.

2 Item 4 Digit Display

4 Item Led Indicator

1 Item Universal Sensor Input (TC, RT)

1 Item Analog Output (0/4-20mA, 0/2-10V)

3 Item Relay or Logic Output. R1,R2 (24V), R3 (15V)

1 Item RS485 Communication Unit

100-240Vac Universal or 24Vac/dc Supply Voltage

Isolation between Input/Output Modules

Auto-Tuning (Automatic settings of PID parameters)

Sensor Error Detection

9 Different Relay Functions

ON/OFF, P, PI, PD, PID Controls

Linear and Time Proportioning Control Output

100ms Sampling and Control Cycle

Before using the device, please follow the instructions below according to the information in this guide.

- Model OC440 devices are modular devices, so that before using the device, control supply voltage and input/output modules if they are appropriate or not by the help of product code
- First of all, connect device to power supply and by using the configuration page, configure the device.
- After configuring the device, adjust set and hysteresis values of the relays which are selected as alarm in operator page.
- Power down the device and according to the connection diagram, apply other connections.
- Prepare the system which will be controlled to be run and power up the system and the device.
- If the control outputs of device will use PID and PID parameters are not entered manually, Run Auto-Tune in order to have the device to calculate these parameters automatically.
- In order to be sure that PID parameters are correct, use a new set value for device and observe the operation.
- Control all functions of the device by stepping through other operating modes.
- Finally, in order to prevent the unauthorized people to observe the system, make the necessary operation for security by entering the configuration page and return to the Process Screen.

This user guide is prepared by following the instruction order above. How these operations are made are explained in detailed in related sections.

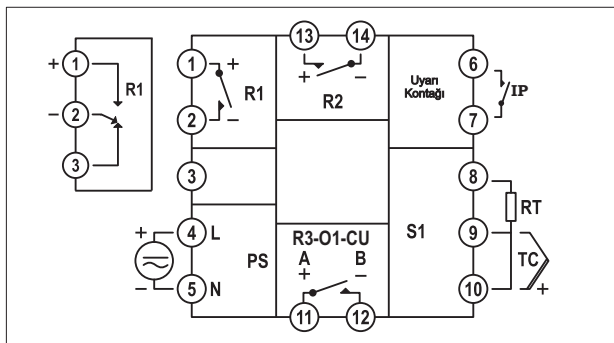
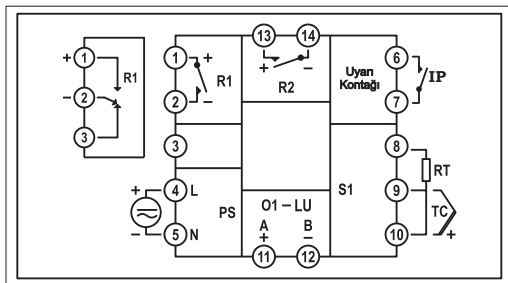
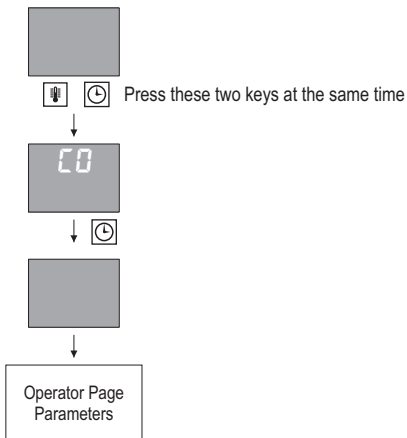



Diagram-1

Module	Explanation
S1	Universal sensor input module (This sensor that is used to measure process value should be connected to the terminal which is identified with suitable symbols in this module).
O1	Analog Output Module (Content of this module is determined by product code and the function of this module is determined by "r 1F" parameter that can be accessed from configuration page).
LU	RS485
R1,R2,R3	Relay Output Modules (Content of this module is determined by product code and the function of this module is determined by "r 1F, r 2F, r 3F" parameters that can be accessed from configuration page).
PS	Supply voltage input (Supply voltage is determined by product code).



To Pass Operator Page



To Enter Operater page press at the same time  and  keys. you will see **CO** on screen. If there is password enter password. If not Fabric code is "0" .

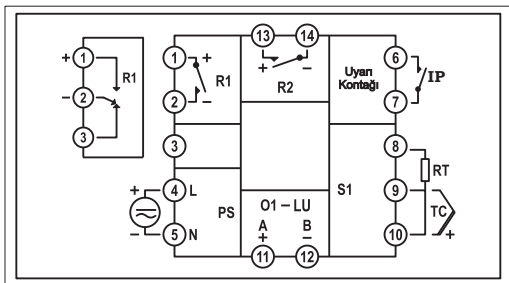

OC440 - / 0 / 0

Supply Voltage :

- 0 = 100-240Vac (Universal)
- 1 = 24Vac/dc

Logic Input Module :

- 0 = N/A
- 1 = 3 Item 15 V Logic Input
- 3 = RS485 Communication Unit

Analog Output Module :

- 0 = N/A
- 1 = 0/4-20mA Current Output
- 2 = 0/2-10V Voltage Output

Relay Output Modules:

- 0 = N/A
- 1 = NO Contact
- 2 = NO / NC Contact
- 3 = 24V Logic Output (to drive SSR)

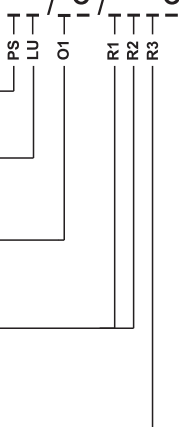

TC Inputs
(B,E,J,K,L,N,R,S,T,U)

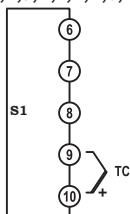

Alarm Contact

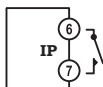

RS-485
Connection *
(MODBUS - RTU)



RT Input (3 Wire)

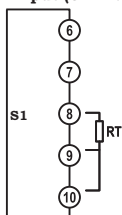

Analog Output*
(0-20mA/0-10V)



Power Connection *

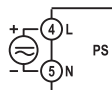

RT Input (2 Wire)

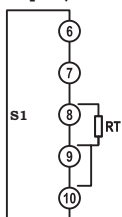

Relays/SSR Outputs*

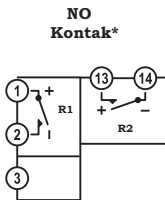

NO/NC
Contact*

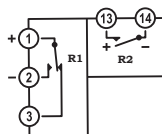

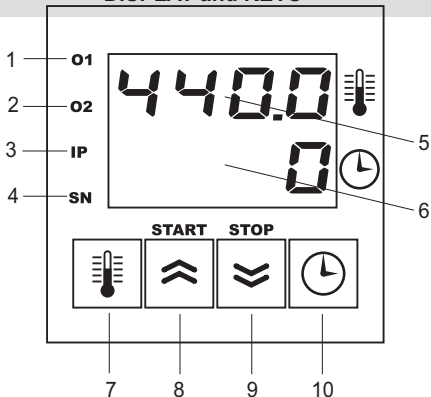

* This optional modules. Look device sticker.

Supply Voltage	100-240Vac/dc: +%10 -%15	24Vac/dc: +%10 -%20
Power Consumption	5W,8VA	
Analog Input (AI1)	Thermocouple (B,E,J,K,L,N,R,S,T,U), Res. Thermometer (Pt100)	
Analog Input	Thermocouple: 10MΩ	
Analog Output (AO1)	Current: 0/4-20mA, 20-4/0mA (RL	Vol.: 0/2-10V, 10-2/0V (RL ≥ 1MΩ)
Digital Outputs (NO Contact: 250Vac	NC Contact: 250Vac Pulse: 24Vdc 20mA
Contact Lifetime	Loadless: 10.000.000 times With 250V 3A res. load: 100.000 times	
Memory	100 year, 100.000 renewals	
Accuracy	+/- %0,2	
Sampling Period	100ms	
Environment	Operation: -10...+55C, Storage: -20...+65C	
Protection	IP20	
Dimensions	Width: 48mm, Height: 48mm, Depth: 108mm	
Panel Cut-Out	45+/-0,5 mm x45+/-0,5 mm	
Weight	154gr	





1	TEMPERATURE DISPLAY	It displays the oven temperature and error messages.
2	TIME DISPLAY	While timing operation continues, it displays the remaining time and after the time finishes, it displays "0".
3	O1 LED	It indicates the state of first output (DO1).
4	O2 LED	It indicates the state of second output (DO2).
5	IP LED	It indicates the state of alarm contact (DI).
6	SN LED	It blinks with a periode of 1 second while the time passes.
7	TEMPERATURE SETTING BUTTON	It is used to enter the Temperature-Setting Mode.
8	UPWARDS ARROW BUTTON	It is used to start the timing operation (START) and to increase the setting values.
9	DOWNWARDS ARROW BUTTON	It is used to stop the timing operation (STOP) and to decrease the setting values.
10	TIME SETTING BUTTON	It is used to enter the Time-Setting Mode.

Setting Temperature Value:

Key is pressed. When "----" is viewed on time indicator, value on temperature indicator is set using  and  keys.

Setting Time Value:

Key is pressed. Just after "----" is displayed on temperature display, by using the  and  keys, value in time display can be set to necessary value.



Starting the Timing Operation:

In order to start timing operation, it is enough to press  (**START**) key or set the state of the Alarm-Contact to close position. When timing operation starts, "SN" led blink for a period of 1sec. If temperature display has an **Error-Message** (Ref:Page-11), timing operation cannot be started.

Terminating the Timing Operation:!

In order to terminate the timing operation, it is enough to press the  (**STOP**) key or set the state of **Alarm-Contact** to Open.

Other Settings:

For other settings,  and  keys are pressed simultaneously and Operator-Page parameters are accessed. Explanation of these parameters can be found in the next section.

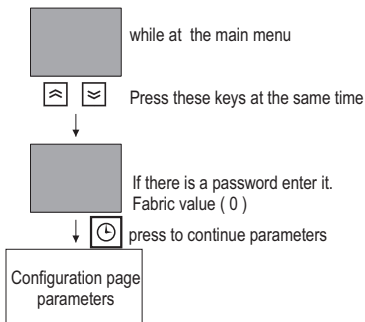

To pass configuration page

Screen

Explanation

Par.01---  In order to restore the settings to the factory default, this parameter should be set to "00" and "☐" key should be pressed for two seconds.

Setting Preferences: 1999 - 9999

Par.02---  It is used to pass to turn fabric parameters. Firstly do 00 this parameter. Than Press  and  keys at the same time. Device is became reset and turn off and on. All the parameters are on fabric values.

Par.03---  It determines the decimal level After change control set and histerezzis parameters.

Setting Range : 0 - 1

Par.04---  "S1" determines the sensor type which is connected to the universal sensor input. This sensor is used to measure the process value.

Setting Preferences : Table 1

Table-1

Al1.T	Sensor Type	Standart	Temperature Range	
			(°C)	(°F)
TC-B	Type B Termocouple	IEC584-1	60, 1820	140, 3308
TC-E	Type E Termocouple	IEC584-1	-200, 840	-328, 1544
TC-J	Type J Termocouple	IEC584-1	-200, 1120	-328, 1562
TC-K	Type K Termocouple	IEC584-1	-200, 1360	-328, 2480
TC-L	Type L Termocouple	DIN43710	-200, 900	-328, 1652
TC-N	Type N Termocouple	IEC584-1	-200, 1300	-328, 2372
TC-R	Type R Termocouple	IEC584-1	-40, 1760	104, 3200
TC-S	Type S Termocouple	IEC584-1	-40, 1760	104, 3200
TC-T	Type T Termocouple	IEC584-1	-200, 400	-328, 752
TC-U	Type U Termocouple	DIN43710	-200, 600	-328, 1112
Rt	Pt100 Rezistans Termometer	IEC751	-200, 840	-328, 1544

Par.05---  When the universal sensor input connection is broken. Set gigh or low value.

Setting Preferences : L0 - Ht





Par.06		Temperature unit. Setting Preferences : °C - °F
Par.07		If there is an input error this value is added. Setting Preferences : - 100 - 100 Birim $^{\circ}$C
Par.08		Filter time adjustment. Setting Preferences : 0.1 - 100 Birim Saniye
Par.09		"R1" Relay running function type selection. Setting Preferences: Table 2-3

Table-2

0	OFF	No relay function.
1	ROC	On / Off heating output.
2	DOC	On / Off cooling output.
3	AHA	Absolute Upper Deviation Alarm
4	ALA	Absolute Lower Deviation Alarm
5	HDA	Relative Upper Deviation Alarm
6	LDA	Relative Lower Deviation Alarm
7	OBA	Outside Band Alarm
8	IBA	Inside Band Alarm
9	PPC	Positive directed PID control
10	NPC	Negative directed PID control
11	OPN	Open valve
12	CLS	Close valve
13	APR	Inside of approach band
14	ODV	Outside of approach band
15	RUN	active If time is running
16	LTU	active when before time is finished
17	EOP	active when time is finished

Table-3

Alarm Type	Abb.	Graphical Representation
ON/OFF Heating	ROC	
ON/OFF Cooling	DOC	
Absolute High Deviation Alarm	AHA	
Absolute Low Deviation Alarm	AIA	
Relative High Deviation Alarm	HDA	
Relative Low Deviation Alarm	LDA	
Outside Band Alarm	OBA	
Inside Band Alarm	IBA	

CSP value in the table is the Control Set Point. **ASP** value is the set value of Control-Output itself that is selected as being alarm (DO1.S, DO2.S).

“1” in the table means Alarm exists and “0” means Alarm does not exist. Hatched fields are the **Hysteresis** fields and their width is **HYS**.

Par.10	r 1L d5b	"R1" Relay lock output. If it is used as alarm select <i>Erb</i> and relay is active upto STOP key is pressed. <i>Setting Preferences : d5b - Erb</i>
Par.11	r 2F EoP	"R2" Relay running function type selection. <i>Setting Preferences : Table 2-3</i>
Par.12	r 2L d5b	"R2" Relay lock output. If it is used as alarm select <i>Erb</i> and relay is active upto STOP key is pressed. <i>Setting Preferences: d5b - Erb</i>
Par.17	o 1F oFF	"O1" Analog output module function selection. <i>Setting Preferences: Table 4</i>

Table-4

0	off	No function
1	PTR	Send process value
2	STR	Send set value
3	PPC	"+" directed control output
4	NPC	"-" directed control output





Par.18		"O1" Analog output type selection.
		Setting Preferences : Table 5

Table-5

0	0-20	0-20mA
1	20-0	20-0mA
2	4-20	4-20mA
3	20-4	20-4mA
4	0-10	0-10V
5	10-0	10-0V
6	2-10	2-10V
7	10-2	10-2V

Par.19		It determines the lower value of output scale when "O1" analog output module is used as a transmitter.
		Setting Preferences : 1999 - 9999 Birimi °C











Par.20		It determines the upper value of output scale when "O1" analog output module is used as a transmitter.
		Setting Preferences : 1999 - 9999 Birimi °C

Par.21		It determines the lower limit value of all set values.
		Setting Preferences : 1999 - 5PHL Birimi °C

Par.22		It determines the upper limit value of all set values.
		Setting Preferences : 5PLL - 9999 Birimi °C

Par.23		Output is reversed when reverse is selected.
		Setting Preferences: rEU (Reverse) - dCr (Normal)

Par.24		Continious Control: Heating is controlled continuously as time independent.
		Setting Preferences : on - off

Par.25		Time Unit Selection Setting Preferences : 5E (second) - nLn (minute) - Hour (hour)
Par.26		Energizing Action Setting Preferences: Cnt (continue while running) - brP (break run)
Par.27		Time period to enter from closed position to open position for non feed back proportional valve (This periode should be measured) Setting Preferences : 10 - 2500 Birim Saniye
Par.28		Only for pozitif PID control aktifve than one way (+) control output lower value is set. Setting Preferences : 00 - 50n Birim
Par.29		Only for pozitif PID control aktifve than one way (+) control output upper value is set. Setting Preferences : 50n - 1000 Birim %
Par.30		Only for pozitif PID control aktifve than one way (+) control output M.R value is set. Setting Preferences: 5oLL - 5oHL Birim %
Par.31		Only for pozitif PID control aktifve and set value is "0" control output upper value is set. Setting Preferences : oFF (Kapalı) , 0.1 - 1000 Birim %
Par.32		Only for Negatif PID control aktifve than two way (+/-) control output lower value is set. Setting Preferences : 1000 - don Birim %
Par.33		Only for Negatif PID control aktifve than two way (+/-) control output upper value is set. Setting Preferences: don - 1000 Birim %
Par.34		Only for Negatif PID control aktifve than two way (+/-) control output M.R value is set. Setting Preferences : doLL - doHL Birim %

Par.35---  **Auto-Tune Set Point:** If user wants the Auto-Tune operation to make for a certain set value, it determines this set value.

Setting Preferences : 1 - 9999 Birimi °C

NOT: Auto--Tune can be done if PID control should be selected.

Par.36---  **P = Pozitive Proportional Band**

Setting Preferences : 1 - 9999 Birimi °C

NOT: If PID control is active.

Par.37---  **N = Negative Proportional Band**

Setting Preferences : 1 - 9999 Birimi °C

NOT: If PID control is active.

Par.38---  **I = Integral time constant.**

Setting Preferences: 1 - 9999 Birimi Saniye

NOT: If PID control is active.

Par.39---  **D = Differrantial time constant.**

Setting Preferences : 1 - 9999 Birimi Saniye

NOT: If PID control is active.

Par.40---  **Control Period:** It determines the period of a control cycle for Analog Output Module.

Setting Preferences: 1 - 250 Birimi Saniye

NOT: If PID control is active.



Par.41---  It determines the dead band of proportional valve. If this value is increased, valve movement becomes stable but sensitivity decreases.

Setting Preferences : 0.1 - 25.0 Birim : %

Par.42	Addr off	It determines the serial communication address. All addresses should be unique that are connected to a serial communication line. <i>Setting Preferences : off (Kapalı) , 1 - 127</i>
Par.43	brUd 9.6	It determines the serial connection speed. <i>Setting Preferences : 4.8 - 9.6 - 19.2 - 38.4</i>
Par.44	Prty Evn	It determines the parity type in serial communication. <i>Setting Preferences : nonE (None) - odd (Odd) - Evn (Even)</i>
Par.45	SC0 0	It determines the security code for Operator page. <i>Setting Preferences : 1999 - 9999</i>
Par.46	SC2 0	It determines the security code for Configuration page. <i>Setting Preferences: 1999 - 9999</i>

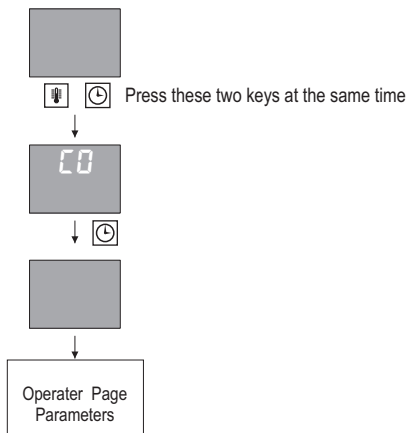

To pass Operator Page



In order to access the operator page parameters, press and hold both   keys for 3-4 second.

Par.47		Operator Password SCO value should be entered to pass operator page. <i>Setting Preferences : 1999 - 9999</i>
Par.48		It determines the progress value per minute if user wants control set value progressed as a ramp. When this parameter is set <i>RPPr</i> parameter should be <i>off</i> . <i>Setting Preferences: off (Kapalı) 0 - 100 Birimi Dakika</i>
Par.49		If Proses value reached to set value, Than Time is started up to time finished. This parameter should be <i>on</i> . When this parameter is <i>on</i> . <i>RPPr</i> parameter should be <i>off</i> . <i>Setting Preferences: on - off</i>
Par.50		Approach Value: When set value and process value difference is greater than this value time is not start and time display is blinking. <i>Setting Preferences: off = 1 - 9999 Birimi °C</i>
Par.51		R1 Relay set value <i>Setting Preferences : 5PLL-5PHL Birimi °C</i>
	⋮	
Par.54		R4 Relay set value <i>Setting Preferences: 5PLL-5PHL Birimi °C</i>
Par.55		Hysteresis: These values are used for ON/OFF control and Auto-Tune operations. (For Auto_Tune operation, choose the smallest value that is bigger than the system uncertainty.) <i>Setting Preferences 1 - 9999 Birimi °C</i>
	⋮	
Par.59		R4 Relay hysteresis value <i>Setting Preferences: 1 - 9999 Birimi °C</i>

Auto-Tune:

After setting the HYS and ATSP parameters to the required value, while this parameter is displayed, Auto-Tune operation is started by pressing the  and  keys. While operation continues, AT message blinks on time display. When the operation finished, **P,I,D**, ve CP parameters are set to new values.

In order to cancel the Auto-Tune operation, while AT message is displayed,  (STOP) key must be pressed.

OC440 series devices can operate with many kinds of sensor types and each output of the device can be used as a separate alarm or control. Therefore, before using this device, input/output types and basic functions should be set properly.

Model OC990 has 1 Item Analog-Input as standard. In addition, 2 Item Digital-Output and 1 Item Analog-Output may be added to system optionally. Analog-Input types, Analog-Output Types and functions, Digital-Output functions are determined with parameters separately. These parameters can be found in Configuration-Page.

Analog-Input is used to measure the temperature value. Sensor type that will be connected to this input is determined by "AI.T" parameter (Table-1).

Unit of Temperature-Value is determined as being °C or °F with "EU" parameter and parameters that related to Temperature-Value uses this unit.

Decimal point of Temperature-Value or other parameters that has a unit of EU is determined by "DP" parameter. Each time that "DP" changes, these parameters should be reset.

Which value will the process value have is determined by "SBA" parameter when temperature sensor is broken or sensor cables break off.

Each Digital-Output of device can be used as being alarm or some control purposes. Each **Digital-Output** has its parameter that determines its own function. Preferences of these parameters are explained in detail in Table-8. Explanations of **ON/OFF Control** and **Alarm-Types** can be found in the next page. **Alarm-Set-Values** of Digital-Outputs that are selected as being alarm are determined with "DO1.S, DO2.S" parameters.

If any Digital-Output is selected as being Alarm, **Alarm-Lock** parameter (DO1.L, DO2.L) of this Digital-Output determines if the Alarm will be locked or not when an Alarm condition happens or lost. When an output enters in **alarm** state and its alarm lock is selected as being "ENB", it can only be **reset by the user**.

If **Servo-Motorized-Valve-Control** will be done, one of the Digital-Outputs' or Relays' function should be selected as being "OPN" and the other should be "CLS". To open or close the valve, these outputs should be used.

Address	Abr.	Explanation	Unit	Mult.	Setting	Min.	Max.
0		Decimal Point (DP)					
1		Process Value	EU	10 [^] DP			
2		Remaining Time	TU				
3		Instantaneous Set Value	EU	10 [^] DP			
4		PID Control Output Value	%	10			
5		Temperature Set Value	EU	10 [^] DP	Yes	-1999	9999
6		Time Set Value	TU		Yes	0	9999
20	Set.1	First Digital Output (DO1) Set Point	EU	10 [^] DP	Yes	-1999	9999
21	Set.2	Second Digital Output (DO2) Set Point	EU	10 [^] DP	Yes	-1999	9999
22	Set.3	Third Digital Output (DO3) Set Point	EU	10 [^] DP	Yes	-1999	9999
23	Set.4	Fourth Digital Output (DO4) Set Point	EU	10 [^] DP	Yes	-1999	9999
24	APPR	Approach Value	EU	10 [^] DP	Yes	0	9999
25	HYS	Hysterisis	EU	10 [^] DP	Yes	1	9999
26	ATSP	Auto-Tune Set Point	EU	10 [^] DP	Yes	-1999	9999
27	PB-P	Proportional Band for "+" Output	EU	10 [^] DP	Yes	1	9999
28	PB-N	Proportional Band for "-" Output	EU	10 [^] DP	Yes	1	9999
29	IT	Integral Time (0 = Off)	s		Yes	0	9999
30	DT	Derivative Time (0 = Off)	s		Yes	0	9999
31	CP	Control Period	s		Yes	-1999	9999
32	DB	Dead Band of Control Output	%	10	Yes	-1999	9999
40	O1LL	Transmitter Scale Low Value	EU	10 [^] DP	Yes	-1000	1000
41	O1HL	Transmitter Scale High Value	EU	10 [^] DP	Yes	1	100
42	TSV	Temperature Error Correction Value	EU	10 [^] DP	Yes	10	2500
43	FTC	Filter Time Contant	s	10	Yes	0	1000
44	VTT	Full Scale Movement Duration of Valve	s		Yes	0	1000
45	SOLL	Low Limit of Single Sided (+) Control Output	%	10	Yes	0	1000
46	SOHL	High Limit of Single Sided (+) Output	%	10	Yes	-1000	1000
47	SOMR	Manual-Reset Directed (+) Control Output	%	10	Yes	-1000	1000
48	DOLL	Low Limit of Double Sided (+/-) Output	%	10	Yes	-1000	1000
49	DOHL	High Limit of Double Sided (+/-) Output	%	10	Yes	-1999	9999
50	DOMR	Manual-Reset Double Sided (+/-) Output	%	10	Yes	-1999	9999

Addr	Kis.		Unit	Factor	Adju	Min.	Max.
51	SPLL	Low Limit of Set Point	EU	10 [^] DP	Yes	-1999	9999
52	SPHL	High Limit of Set Point	EU	10 [^] DP	Yes	-1999	9999
60	S1..T	Universal Analog Input (AI1) Type	Table-1		Yes	0	10
61	Eu	Temperature Unit (EU)			Yes	0	1
62	DP	Measurement Decimal Point (DP) ⁽¹⁾			Yes	0	1
63	s1bL	Sensor Connection is Broken Action			Yes	0	1
64	R1.f	R1 Function	Tables 2-3		Yes	0	17
65	R1.l	R1 Lock			Yes	0	1
66	R2.f	R2 Function	Tables 2-3		Yes	0	17
67	R2.l	R2 Lock			Yes	0	1
68	R3.f	R3 Function	Tables 2-3		Yes	0	17
69	R3.l	R3 Lock			Yes	0	1
70	R4.f	R4 Function	Tables 2-3		Yes	0	17
71	R4.l	R4 Lock			Yes	0	1
72		Position Feedback			Yes	0	1
73	O1.f	First Analog Output (AO1) Function	Table-4		Yes	0	4
74	O1.t	First Analog Output (AO1) Type	Table-5		Yes	0	7
75	O2.f	Second Analog Output (AO2) Function	Table-4		Yes	0	4
76	O2.t	Second Analog Output (AO2) Type	Table-5		Yes	0	7
77	CF	Control Form			Yes	0	1
78	CCNT	Continious Control			Yes	0	1
79	TU	Time Unit			Yes	0	2

Bit Type Parameters Communication Address		
Address	Setting Perm.	Explanation(1 / 0)
0		First Digital Output (DO1) (ON / OFF)
1	No	Second Digital Output(DO2) (ON / OFF)
2	No	Third Digital Output(DO3) (ON / OFF)
3	No	Fourth Digital Output (DO4) (ON / OFF)
4	No	Below Scale Error (Yes / No)
5	No	Above Scale Error (Yes / No)
6	No	Broken Sensor Error(Yes / No)
7	No	Process Measurement Error (Yes / No)
8	Yes	Auto-Tune (Start / Stop)
9	Yes	Operation (Start / Stop)

Error Message	Meaning
-SB-	Sensor connection is broken.
-Uf-	Process value is below the sensor scale.
-Of-	Process value is above the sensor scale.
nn	Process value is too high that it cannot be displayed.
-vv-	Process value is too low that it cannot be displayed.

www.ordel.com.tr

Üretici ve Teknik Servis :

ORDEL Ltd. Şti. Uzayçağı Cad. 1252. Sok. No:12 OSTİM / ANKARA

Tel:+90 312 385 70 96 (PBX) Fax: +90 312 385 70 78

ORDEL