

AC491/AC941

Advanced Controller Device USER'S GUIDE

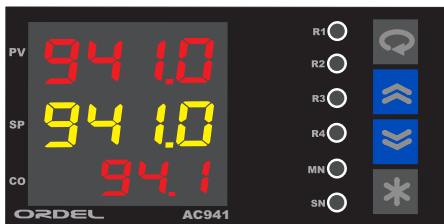

ORDEL



- Before using the device, please read the warnings below and this guide carefully. The accidents or damages resulting from not following the warnings included in this guide are under user's responsibility.
- This device is intended to be used by qualified personnel in industrial environments, do not use in houselike environments.
- Do not use the device at places where corrosive, flammable and explosive gases exist. Contact points may create electrical discharge and this may cause explosion or fire.
- Do not allow metal fragments or lead wire scraps or liquid matters to fall inside this device. Otherwise fire or electrical shock may happen.
- Take the necessary precautions in order to prevent accidents and damages that may result in case the device gets faulty.
- There is no fuse or switch that brings the device in power down state, these should be added to the system by the user.
- Sensor and signalling cables should not be routed close to the power cables or inductive load cables.
- Do not power up the device before the connections related with the device are performed in accordance with connection diagram.
- Do not power up the device before the connections related with the device are performed in accordance with the connection diagram. While the device is powered, do not touch on the terminals.
- Configuration settings at factory out should be changed according to the user's preferences. The accidents and damages resulting from incorrect configuration settings are under users' responsibility.
- Never disassemble, repair and modify the device. These should be carried out by authorized service.

TOPIC	Page Number
Safety Precautions.....	2
Contents	3
Device Description.....	4
Preparations Before Use	5
Connection Diagram.....	6
Product Code.....	8
Technical Specifications.....	9
Temperature Sensors.....	10
Display and Key Functions	11
Configuration	13
Configuration Page Parameters	15
Operator Page	25
Operator Page Parameters	26
Auto-Tune Operation.....	29
Operating Modes.....	30
Determining Set Point Remotely.....	31
Proportional Motor Valve Control.....	32
Serial Communication.....	33
Configuration Guide	37

AC491/AC941 Model devices are modular devices that have been designed to measure and control different types of processes variables and all modules can be configured separately. Complying international standards, reliability and user friendly usage features are the design principles of these devices. So that, they are ergonomic devices that can be used easily in many different industrial sectors.

- 2 Item 4 Digit, 1 Item 3 Digit LED Display
- 6 Item Led Indicator
- 1 Item Transmitter Power Supply
- 1 Item Universal Sensor Input (TC, RT, mA, mV, V)
- 1 Item Auxiliary Analog Input (0/4-20mA)*
- 1 Adet Potentiometer Input (100-1500Ω)*
- 2 Item Digital Input (15V)*
- 1 Item RS485 Communication Unit*
- 1 Item Analog Output (0/4-20mA, 0/2-10V)*
- 4 Item Relay or Logic Output
- 100-240Vac Universal or 24Vac/dc Supply Voltage
- Isolation between Input/Output Modules

- Proportional Valve Control with position feedback
- Proportional Valve Control Without Feedback
- PID Heating/Cooling
- Auto-Tuning (Automatic settings of PID parameters)
- Automatic/Manual/Program Operating Modes
- Bumpless Transfer Ability**
- Sensor Error Detection
- Remote Set Point (Determining Set Point Remotely)**
- 4 Item Optional Set Point**
- Ramp Function
- Retransmission (For Process and Set Vaues)
- 15 Different Relay Function
- ON/OFF, P, PI, PD, PID Controls
- Linear and Time Proportioning Control Output
- 100ms Sampling and Control Cycle
- Standard MODBUS RTU Communication Protocol**
- Master-Slave, Cascade Control Applications**

* Optional

** Only with optional module

Before using the device, please follow the instructions below according to the information in this guide.

- Model AC491/941 devices are modular devices, so that before using the device, control supply voltage and input/output modules if they are appropriate or not by the help of product code
- First of all, connect device to power supply and by using the configuration page, configure the device.
- After configuring the device, adjust set and hysteresis values of the relays which are selected as alarm in operator page.
- Power down the device and according to the connection diagram, apply other connections.
- Prepare the system which will be controlled to be run and power up the system and the device.
- If the control outputs of device will use PID and PID parameters are not entered manually, Run Auto-Tune in order to have the device to calculate these parameters automatically.
- In order to be sure that PID parameters are correct, use a new set value for device and observe the operation.
- Control all functions of the device by stepping through other operating modes.
- Finally, in order to prevent the unauthorized people to observe the system, make the necessary operation for security by entering the configuration page and return to the Process Screen.

This user guide is prepared by following the instruction order above. How these operations are made are explained in detailed in related sections.

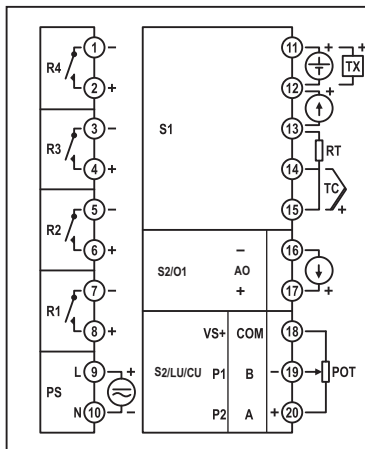
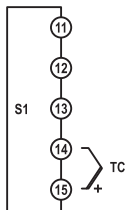

Diagram-1

Module	Explanation
S1	Universal sensor input module (This sensor that is used to measure process value should be connected to the terminal which is identified with suitable symbols in this module).
S2/O1	0/4-20mA Auxiliary analog input or analog output module
S3/LU/CU	100-1500Ω Potentiometer input or RS485 MODBUS RTU or Logic Input module.
R1,R2,R3,R4	Relay Output Modules (Content of this module is determined by product code and the function of this module is determined by "r 1F, r 2F, r 3F, r 4F" parameters that can be
PS	Supply voltage input (Supply voltage is determined by product code).

TC Input
(B,E,J,K,L,N,R,S,T,U)



RT Input (3 Wires)

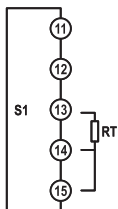

RT Input (2 Wires)

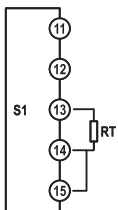

Current Input (mA)

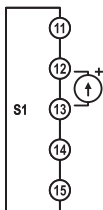

Voltage Input (V)

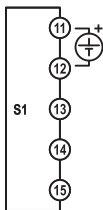

Transmitter Supply
(24Vdc/30mA)

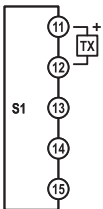

Supply Connection *

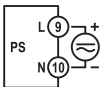

Aux. Current Input *
(mA)



Potentiometer
Connection *
(100 - 1500Ω)

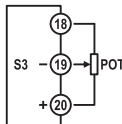

RS-485
Communication *
Connection
(MODBUS - RTU)

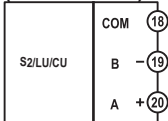

Logic Input *
(VS±=15V)

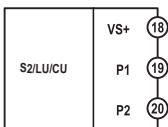

Analog Output *

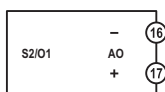

Relay Outputs *

NO Contact * **NO/NC Contact ***

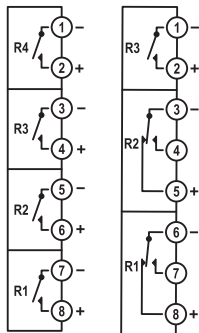

* Optional. Please check device type label.

AC941-
AC491- T T / 0/
 RS LU O1 R1 R2 R3 R4

Supply Voltage :

0 = 100-240Vac (Universal)

1 = 24Vac/dc

S3/LU/CU Module :0 = Proportional Feedback Connection
(Potentiometer)

1 = 2 Item 15V Logic Input

3 = RS485 Communication Unit

S2/AO Module :

0 = Auxiliary Current Input

1 = 0/4-20mA Current Output

2 = 0/2-10V Voltage Output

Relay Output Module :

0 = N/A

1 = NO Contact

2 = 24V Logic Output (To drive SSR)

Relay output modules can be code as “contact” or “logic” in the product code, but in user manual, only “relay” term is refer to outputs.

Power Supply (PS)	100-240Vac/dc : +%10 -%15	24Vac/dc : +%10 -%20
Power Consumption	6W,10VA	
Universal Sensor Input (S1)	Thermocouple : B,E,J,K,L,N,R,S,T,U	
	Two Wire Transmitter : 4-20mA	
	Resistance Thermometer : PT100	
	Current : 0/4-20mA	
	Voltage : 0-50mV, 0/2-10V	
Auxiliary Analog Input (S2)	0/4-20mA	
Potentiometer Input (S3)	100-1500Ω	
Transmitter Supply (TX)	24Vdc (I _{sc} = 30mA)	
Analog Input Impedance	Thermocouple, mV : 10MΩ	
	Current : 10Ω	
	Voltage : 1MΩ	
Analog Output (O1)	Current : 0/4-20mA (RL ≤ 500Ω)	Voltage : 0/2-10V (RL ≥ 1MΩ)
Relay Outputs(R1,R2,R3,R4)	Contact : 250Vac, 3A	Logic Output : 24Vdc, 20mA
Relay Lifetime	Without Load : 10.000.000 switching	
	With 250V, 3A Resistive Load : 100.000 switching	
Memory	100 years, 100.000 renewals	
Accuracy	+/- %0.2	
Sampling Period	100ms	
Environment Temperature	Operation : -10...+55C	Storage : -20...+65C
Protection	Front Panel : IP54	Trunk : IP20
Dimensions	491: Length : 48mm Height : 96mm Deep : 110mm	
	941: Length : 96mm Height : 48mm Deep : 110mm	
Panel cut-out Dimensions	491: 46+/-0,5 mm x 91+/-0,5 mm 941: 91+/-0,5 mm x 46+/-0,5 mm	
Weight	430gr	

Sensor Type	Standard	Temperature Range	
		(C°)	(°F)
Type-B Thermocouple (Pt%18Rh-	IEC584-1	60, 1820	140, 3308
Type-E Thermocouple (Cr-Const)	IEC584-1	-200, 840	-328, 1544
Type-J Thermocouple (Fe-Const)	IEC584-1	-200, 1120	-328, 1562
Type-K Thermocouple (NiCr-Ni)	IEC584-1	-200, 1360	-328, 2480
Type-L Thermocouple (Fe-Const)	DIN43710	-200, 900	-328, 1652
Type-N Thermocouple (Nicrosil-	IEC584-1	-200, 1300	-328, 2372
Type-R Thermocouple (Pt%13Rh-	IEC584-1	-40, 1760	104, 3200
Type-S Thermocouple (Pt%10Rh-	IEC584-1	-40, 1760	104, 3200
Type-T Thermocouple (Cu-Const)	IEC584-1	-200, 400	-328, 752
Type-U Thermocouple (Cu-Const)	DIN43710	-200, 600	-328, 1112
Pt-100 Resistance Thermometer	IEC751	-200, 840	-328, 1544

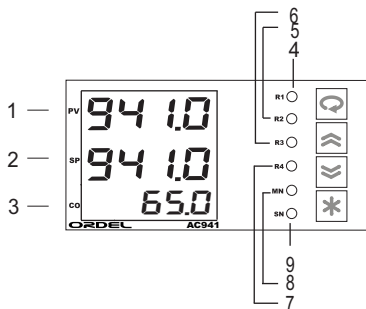
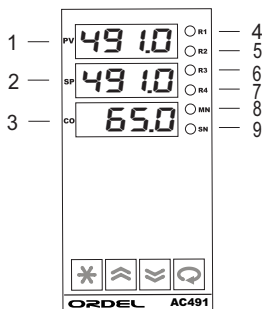

PROCESS-SCREEN:

Just after powering up the device, after showing program version for 2 seconds, “PV” display shows measured process value or error message and “SP” display shows the most used parameter depending to operation mode. This screen is called **Process-Screen**. During normal operations, this screen is used.

1	PV DISPLAY	Process value or error messages are shown in Process-Screen, other screens show the parameter name.
2	SP DISPLAY	In Process-Screen, this display's function is determined
3	CO DISPLAY	This indicator is only activated in Process-Screen and it shows the valve position or control output level according to control type..
4	R1 LED	It indicates the “R1” relay is powered up.
5	R2 LED	It indicates the “R2” relay is powered up.
6	R3 LED	It indicates the “R3” relay is powered up.
7	R4 LED	It indicates the “R4” relay is powered up.
8	MN LED	It indicates the manual control is on.
9	SN LED	N/A in this model





SYMBOLISATION OF ALPHABETICAL CHARACTERS

A	B	C	D	E	F	G	H	I	J	K	L	M
A	b	C	d	E	F	G	H	I	J	K	L	M
N	O	P	Q	R	S	T	U	V	W	X	Y	Z
n	o	P	q	r	s	t	u	v	w	x	y	z

ERROR MESSAGES

<i>Err.1</i>	Sensor connection is broken at "S1" input.
<i>Err.2</i>	Signal is broken at "S2" input.
<i>Err.3</i>	Potentiometer at "S3" input failed.
----	Process value is above the display scale.
----	Process value is below the display scale.

KEY FUNCTIONS

	While in Process-Screen, if it is pressed shortly, locked relays are resetted. Pressing for 5 seconds will change the operating mode. While in other screens, it is used to revert to the first page. Pressing for 2 seconds will activate the Process-Screen.
	It is used to change the parameter option or parameter value.
	It is used to change the parameter option or parameter value.
	In any page, pressing for a while activates the next parameter. While in Process-Screen, pressing for 5 seconds will start the Auto-Tune operation. For submit operations, it must be pressed for 2 seconds.

AC491/AC941 series include control devices that are designed for multi-purpose usage. So that they can be used in any environments that have appropriate input/output modules. These devices may work with different types of sensors and input signals and may control all outputs separately. So that, before using AC491/941 device, input/output types and functions, control types and usage preferences should be determined carefully.

According to the product code, AC491/941 series devices may have 2 analog input, 2 logic input, 1 analog output and four relay output modules. Module types, functions and scales are determined with parameters which can be accessed in configuration page.

Furthermore, common parameters that determines the control type and operating mode, also necessary setting for control algorithm may be accessed in configuration page.

Before using an unconfigured device, firstly power on the device and make configuration by following the instructions below:

Entering the configuration page and setting up parameters:

- ◆ In order to enter the configuration page, press “[*]” and “[<]” keys simultaneously and continuously until “L2” message appears in “PV” display when device is energized.
- ◆ Set the security code by pressing “[>]” and “[<]” keys by setting the value of “SP” display to configuration page security code when “L2” message still appears in PV display (Default factory setting of this security code is “0”).
- ◆ If the security code is not valid when you have pressed “[<]” key, Process-Screen is to be reverted, otherwise first parameter of the configuration page is accessed.
- ◆ In parameter display, parameter name is displayed in “PV” display, preferences of the parameter setting is displayed in “SP” display.
- ◆ Now, you can access other configuration parameters in order by pressing “[<]” key .
- ◆ In order to change preferences of parameter setting, use “[>]” and “[<]” keys, in order to step to the next parameter use “[<]” key. A short time press of “[*]” key makes you to access the start of page, a long time press makes you to return the Process-Screen.
- ◆ Below, you can find a graphical representation of these instructions in **Figure-3**.
- ◆ **Note:** In order to step through in configuration page with parameter numbers displayed, press “[*]” and “[<]” keys simultaneously.

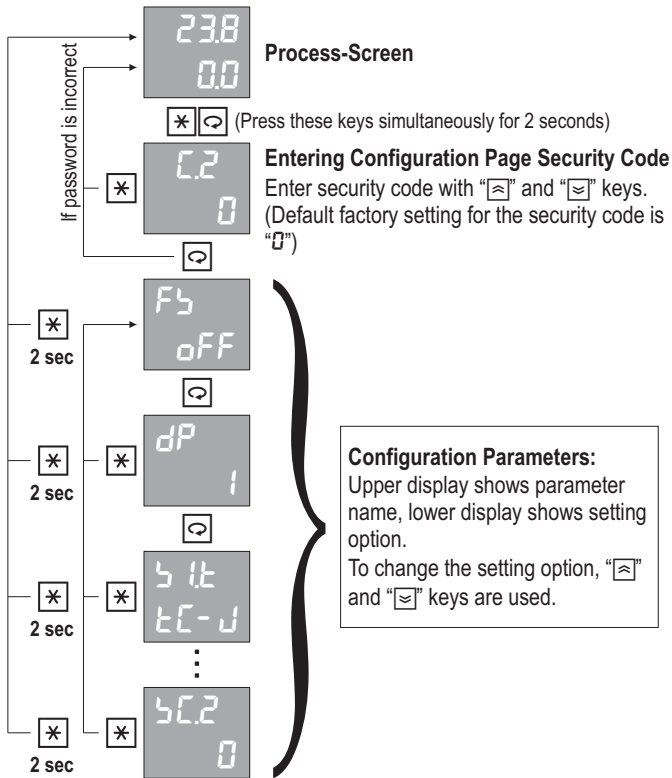

Figure-3

Detailed information about configuration page parameters can be found in the next section.

Par. 01



In order to restore the settings to the factory default, this parameter should be set to "on" and "☐" key should be pressed for two seconds.

Setting Preferences: OFF, on

Par. 02



It determines the decimal level (number of digits after dot) of all parameters which have a unit of "EU".

Setting Range : 0 - 3

Warning: When this parameter has been changed, all parameters which have a unit of "EU" should be set again.

Note: "EU", which is determined by "HU" parameter is a temperature unit for thermocouple or resistance thermometer measurements. Otherwise, it is an engineering unit that represents the measured variable.

Par. 03

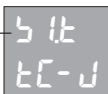

"S1" determines the sensor type which is connected to the universal sensor input. This sensor is used to measure the process value.

Setting Preferences: Table-1

Table-1	No	Sensor Type
tC-b	0	Type-B Thermocouple (Pt%18Rh-Pt)
tC-E	1	Type-E Thermocouple (Cr-Const)
tC-J	2	Type-J Thermocouple (Fe-Const)
tC-K	3	Type-K Thermocouple (NiCr-Ni)
tC-L	4	Type-L Thermocouple (Fe-Const)
tC-n	5	Type-N Thermocouple (Nicrosil-Nisil)
tC-r	6	Type-R Thermocouple (Pt%13Rh-Pt)
tC-S	7	Type-S Thermocouple (Pt%10Rh-Pt)
tC-t	8	Type-T Thermocouple (Cu-Const)
tC-U	9	Type-U Thermocouple (Cu-Const)
r t	10	Pt-100 Resistance Thermometer
0-50	11	0-50mV
0-20	12	0-20mA
4-20	13	4-20mA
0-10	14	0-10V
2-10	15	2-10V

Par. 04		It determines the lower scale value of "S1" universal sensor input module.	
		Setting Range : -999.9 - 999.9	Unit : EU

Par. 05		It determines the higher scale value of "S1" universal sensor input module.	
		Setting Range : -999.9 - 999.9	Unit : EU

Par. 06		It determines the value which scala will be set to when the universal sensor input connection is broken.	
		Setting Preferences : L (Low value) , H (High value)	

Par. 07		It determines the function of "S2" auxiliary analog input module.	
		Setting Preferences : Table-2	

Table-2	No	Analog Input Function
oFF	0	N/A
RP _L	1	Measured value is added to process value.
SP _L	2	Measured value is subtracted from process value.
PF _b	3	It is used to get the valve position.
rSP	4	It is used to determine the set point remotely.

Par. 08		It determines the signal type that is connected to "S2" auxiliary analog input.	
		Setting Preferences : 0-20 (0-20mA) , 4-20 (4-20mA)	

Par. 09		It determines the scale lower limit of "S2" auxiliary analog input module.	
		Setting Range : -999.9 - 999.9	Unit : EU

Par. 10		It determines the scale higher limit of "S2" auxiliary analog input module.	
		Setting Range : -999.9 - 999.9	Unit : EU

Par. 11		If the signal that is connected to "S2" auxiliary analog input module cannot be received, then it determines the scale value.	
		Setting Preferences : L (Low Value) , H (High Value)	







Par. 12		<p>It determines the function of "S3" potentiometer input module.</p> <p><i>Setting Preferences</i> : Table-2</p>
Par. 13		<p>It determines the lower scale value of "S3" potentiometer input module.</p> <p><i>Setting Range</i> : -999.9 - 999.9 <i>Unit</i> : EU</p>
Par. 14		<p>It determines the higher scale value of "S3" potentiometer input module.</p> <p><i>Setting Range</i> : -999.9 - 999.9 <i>Unit</i> : EU</p>
Par. 15		<p>It determines scale value, when the potentiometer connected to "S3" potentiometer input module is broken.</p> <p><i>Setting Preferences</i> : L (Alt değer) , H (Üst değer)</p>
Par. 16		<p>It determines the temperature unit for the measurements of thermocouples or resistance thermometers.</p> <p><i>Setting Preferences</i> : °C (°C), °F (°F)</p>
Par. 17		<p>While measuring with thermocouples or resistance thermometers, in order to correct measurement errors, it is added to measured value.</p> <p><i>Setting Range</i> : -100.0 - 100.0 <i>Unit</i> : EU</p>
Par. 18		<p>It determines the time constant of digital filter that is applied to analog inputs. If this value is increased, reading stability increases but reading speed decreases.</p> <p><i>Setting Range</i> : 0.1 - 10.0 <i>Unit</i> : sec</p>
Par. 19		<p>It determines the function of "LU" logic input module.</p> <p><i>Setting Preferences</i> : Table-3</p>

Table-3	No	Logic Input Function
off	0	N/A
SpS	1	It is used to select the set point remotely.

Par. 20

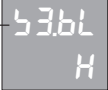
It determines the function of "O1" analog output module.

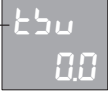
Setting Preferences : Table-4

Table-4	No	Analog Output Function
oFF	0	N/A
PCo	1	Positive directed PID control ouput.
nCo	2	Negative directed PID control ouput.
PuL	3	Process Transmitter
SPT	4	Set Point Transmitter

Par. 21

It determines the type of "O1" analog output module.

Setting Preferences : Table-5

Table-5	No	Analog Output Type
0-20	0	0-20mA
20-0	1	20-0mA
4-20	2	4-20mA
20-4	3	20-4mA
0-10	4	0-10V
10-0	5	10-0V
2-10	6	2-10V
10-2	7	10-2V

Note: In order to be able to use the first four preferences, this module should be identified as being "0/4-20mA" in product code. As for the last four preferences, "0/2-10V" should be used as identifying code.

Par. 22

It determines the lower value of output scale when "O1" analog ouput module is used as a transmitter.

Setting Range : -999.9 - 999.9

Unit : EU

Par. 23

It determines the upper value of output scale when "O1" analog ouput module is used as a transmitter.

Setting Range : -999.9 - 999.9

Unit : EU

Par. 24



It determines the function of "R1" relay output module.

Setting Preferences : Table-6

Table-6	No	Relay Function	
OFF	0	N/A	
ULC	1	Upper Limit Control	
LLC	2	Lower Limit Control	
ULR	3	Upper Limit Alarm	
LLR	4	Lower Limit Alarm	
UdR	5	Upper Deviation Alarm	

ALARMS

LdR	6	Lower Deviation Alarm	ALARMS	
obR	7	Outside Band Alarm		
cbR	8	Inside Band Alarm		
PCo	9	Positive directed PID control output		
nCo	10	Negative directed PID control output		
POF	11	Positive control output alert		
NOF	12	Negative control output alert		
oPn	13	Output of proportional valve opening		
CLC	14	Output of proportional valve closing		
$dBCL$	15	Control with serial communication		

Note: Hatched areas are hysteresis areas and hysteresis of each relay is determined with its " $\Delta Et.n$ " parameter. ("**N**" represents the relay number)

"1" in table means that related relay is powered on and "0" means powered off.

Par. 25		It determines the function of "R2" relay output module. <i>Setting Preferences</i> : Table-6
Par. 26		It determines the function of "R3" relay output module. <i>Setting Preferences</i> : Table-6
Par. 27		It determines the function of "R4" relay output module. <i>Setting Preferences</i> : Table-6
Par. 28		It determines the function of bar indicator. <i>Setting Preferences:</i> dEu (Deviation from set value) CoL (Control Output Level)

Par. 29	bdb 10.0	<p>If bar indicator indicates the deviation from set value, it determines the indicator band.</p> <p>Setting Range : 0.1 - 999.9</p> <p>Unit : EU</p>
Par. 30	↳PLL -999.9	<p>It determines the lower limit value of all set values.</p> <p>Setting Range : -999.9 - [↳PHL]</p> <p>Unit : EU</p>
Par. 31	↳PHL 999.9	<p>It determines the upper limit value of all set values.</p> <p>Setting Range : [↳PLL] - 999.9</p> <p>Unit : EU</p>
Par. 32	↳Pr off	<p>It determines the progress value per minute if user wants control set value progressed as a ramp.</p> <p>Setting Range : off , 0.0 - 6000.0</p> <p>Unit : EU</p>
Par. 33	CF rEu	<p>It determines the control form (direction).</p> <p>Setting Preferences: dCr (While process value is increasing, output increases too), rEu (While process value is decreasing, output decreases too)</p>
Par. 34	Popb off	<p>It determines the proportional band of positive directed PID control output.</p> <p>Setting Range : off(ON/OFF control) , 0.1 -</p> <p>Unit : EU</p>
Par. 35	noPb off	<p>It determines the proportional band of negative directed PID control output.</p> <p>Setting Range : off(ON/OFF control) , 0.1 -</p> <p>Unit : EU</p>
Par. 36	It off	<p>Integral time constant.</p> <p>Setting Range : off(Closed) , 1 - 6000</p> <p>Unit : sec</p>
Par. 37	dt off	<p>Differential time constant.</p> <p>Setting Range : off(Closed) , 0.1 - 999.9</p> <p>Unit : sec</p>

Par. 38	CP 2.0	It determines the period of a control cycle. Setting Range : 0.1 - 600	Unit : sec
Note: In order to prevent from oscillations caused from control period, control period should be selected minimum to system dead time.			
Par. 39	Coll 1000	It determines the lower limit of PID control output. Setting Range : 1000 - [CoHL]	Unit : %
Par. 40	CoHL 1000	It determines the higher limit of PID control output. Setting Range : [Coll] - 1000	Unit : %
Par. 41	Cobl 00	It determines the initial value of PID control output. (When integral is closed, it is the control output value which process value and set value are equal) Setting Range : 1000 - 1000	Unit : %
Par. 42	Codb 0.1	While using double sided PID control, it determines the dead band of control output while changing direction. Setting Range : 0.1 - 250	Unit : %
Par. 43	utb 100	Time period to enter from closed position to open position for non feed back proportional valve (This periode should be measured) Setting Range : 10 - 2500	Unit : sec
Par. 44	udb 10	It determines the dead band of proportional valve. If this value is increased, valve movement becomes stable but sensitivity decreases. Setting Range : 0.1 - 250	Unit : %
Par. 45	S3LC rrrr	Lower calibration of potentiometer that is connected to "S3". While this parameter is shown, potentiometer should be brought to lowest position and this position should be saved by pressing and holding the "[C]" key for 2 seconds.	
Par. 46	S3HC rrrr	Higher calibration of potentiometer that is connected to "S3". While this parameter is shown, potentiometer should be brought to highest position and this position should be saved by pressing and holding the "[C]" key for 2 seconds.	

Par. 47	<div style="background-color: #cccccc; padding: 5px; border: 1px solid black;"> A_tF P_zd </div>	It determines the control type for Auto-Tune operation. <i>Setting Preferences : P, P_z, P_zd (P, PI, PID)</i>
Par. 48	<div style="background-color: #cccccc; padding: 5px; border: 1px solid black;"> ACP on </div>	It allows the control period is calculated automatically by Auto-Tune operation.
Par. 49	<div style="background-color: #cccccc; padding: 5px; border: 1px solid black;"> A_tSP off </div>	If user wants the Auto-Tune operation to make for a certain set value, it determines this set value. <i>Setting Range : off(Closed) , 199.9 - 999.9</i> <i>Unit : EU</i>
Par. 50	<div style="background-color: #cccccc; padding: 5px; border: 1px solid black;"> A_tHr 2.0 </div>	Hysteresis value for Auto-Tune operation. It should be set to 5-20 times of system instability. <i>Setting Range : 0.1 - 100.0</i> <i>Birim : EU</i>
Par. 51	<div style="background-color: #cccccc; padding: 5px; border: 1px solid black;"> Addr 1 </div>	It determines the serial communication address. All addresses should be unique that are connected to a serial communication line. <i>Setting Range : off(Closed) , 1 - 255</i> <i>Birim : EU</i>
Par. 52	<div style="background-color: #cccccc; padding: 5px; border: 1px solid black;"> bAUD 9.6 </div>	It determines the serial connection speed. <i>Setting Preferences : 9.6 , 19.2 , 38.4</i> <i>Birim : Kbps</i>
Par. 53	<div style="background-color: #cccccc; padding: 5px; border: 1px solid black;"> Prty Eun </div>	It determines the parity type in serial communication. <i>Setting Preferences : nonE(None) , odd(Odd) , Eun(Even)</i>
Par. 54	<div style="background-color: #cccccc; padding: 5px; border: 1px solid black;"> C_{SP} on </div>	Permission for changing the control set value by the operator. <i>Setting Preferences: off(Off) , on(On)</i>
Par. 55	<div style="background-color: #cccccc; padding: 5px; border: 1px solid black;"> A_{SP} on </div>	Permission for changing the "SEt" set value that belongs to relays. <i>Setting Preferences: off(Off) , on(On)</i>

Par. 56		Permission for changing the hysteresis ("HY55n") value by the operator. <i>Setting Preferences: OFF(Off) , ON(On)</i>	
Par. 57		Permission for changing the mode to Manual-Control. <i>Setting Preferences: OFF(Off) , ON(On)</i>	
Par. 58		Permission for changing the mode to Automatic-Control. <i>Setting Preferences: OFF(Off) , ON(On)</i>	
Par. 59		Permission for starting the Auto-Tune operation. <i>Setting Preferences: OFF(Off) , ON(On)</i>	
Par. 60		It determines the "COP" parameter is shown or not which represents the PID control output level in operator page. <i>Setting Preferences: OFF(Off) , ON(On)</i>	
Par. 61		While in operator parameters, it determines the automatic return time to Process-Screen. <i>Setting Range : OFF(Off) , 1 - 25</i>	<i>Unit : sec</i>
Par. 62		It determines the security code for Configuration page. <i>Setting Range : 1999 - 9999</i>	

Existing configuration determines which parameters will be used in operator page and only necessary parameters are displayed. These parameters which are determined in configuration are used in normal operation conditions. So, While in Process Screen, by pressing key " \square " key, user can access these parameters in any time and by pressing the " \ast " key, user returns to Process-Screen again. Setting permission of the changeable parameters can be set with the related parameters in configuration page. While in any parameter in operator page, if user does not press any key, Process-Level is to be returned after the time which is determined by "RrL" parameter, pass.

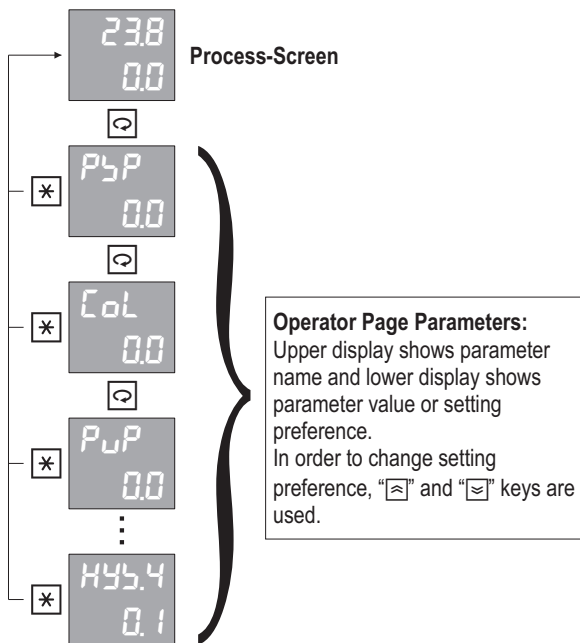

Detailed information about operator page parameters can be found in the next section.

<p><i>P_{U1}</i> 00</p>	<p>It displays the data incoming from "S1" universal sensor input. In order to make this parameter visible, "b2F" or "b3F" parameters should be selected as "RP_U" or "bP_U".</p>	<p>Unit : EU</p>
<p><i>P_{U2}</i> 00</p>	<p>It displays the data incoming from "S2" auxiliary analog input. In order to make this parameter visible, "b2F" parameter should be selected as "RP_U" or "bP_U".</p>	<p>Unit : EU</p>
<p><i>P_{U3}</i> 00</p>	<p>It displays the data incoming from "S3" auxiliary analog input. In order to make this parameter visible, "b3F" parameter should be selected as "RP_U" or "bP_U".</p>	<p>Unit : EU</p>
<p><i>P_{SP}</i> 00</p>	<p>It shows the instantaneous set value.</p>	<p>Unit : EU</p>
<p><i>CoL</i> 00</p>	<p>It displays the level of PID control output. In order to make this parameter visible, "CoP" parameter which is in configuration page should be selected as being "on".</p>	<p>Unit : %</p>
<p><i>P_{VP}</i> 00</p>	<p>It shows the position of proportional valve. In order to make this parameter visible, "b2F" or "b3F" parameters should be selected as being "PFb" in configuration page.</p>	<p>Unit : %</p>
<p><i>b5P.1</i> 00</p>	<p>It determines the 1th optional set value. In order to make this parameter visible, "LUF" parameter should be selected as being "bP₅".</p>	<p>Setting Range : [bP_{LL}] - [bP_{HL}] Unit : EU</p>
<p><i>b5P.2</i> 00</p>	<p>It determines the 2th optional set value. In order to make this parameter visible, "LUF" parameter should be selected as being "bP₅".</p>	<p>Setting Range : [bP_{LL}] - [bP_{HL}] Unit : EU</p>
<p>⋮</p>	<p>⋮</p>	
<p><i>b5P.4</i> 00</p>	<p>It determines the 4th optional set value. In order to make this parameter visible, "LUF" parameter should be selected as being "bP₅".</p>	<p>Setting Range : [bP_{LL}] - [bP_{HL}] Unit : EU</p>

SE1 0.0	It determines the set value of "R1" module. In order to make this parameter visible, "r1F" parameter should be selected as ALARM.	Setting Range : [bPLL] - [bPHL]	Unit : EU
SE2 0.0	It determines the set value of "R2" module. In order to make this parameter visible, "r2F" parameter should be selected as ALARM.	Setting Range : [bPLL] - [bPHL]	Unit : EU
SE3 0.0	It determines the set value of "R3" module. In order to make this parameter visible, "r3F" parameter should be selected as ALARM.	Setting Range : [bPLL] - [bPHL]	Unit : EU
SE4 0.0	It determines the set value of "R4" module. In order to make this parameter visible, "r4F" parameter should be selected as ALARM.	Setting Range : [bPLL] - [bPHL]	Unit : EU
HYS 0.1	It determines the control hysteresis value. In order to make this parameter visible, one of the proportional band should be selected as being "OFF".	Setting Range : 0.1 - 100.0	Unit : EU
HYS1 0.1	It determines the hysteresis value of "R1" module. In order to make this parameter visible, "r1F" parameter should be selected as being ALARM.	Setting Range : LEL (Locked) , 0.1 - 100.0	Unit : EU
HYS2 0.1	It determines the hysteresis value of "R2" module. In order to make this parameter visible, "r2F" parameter should be selected as being ALARM.	Setting Range : LEL (Locked) , 0.1 - 100.0	Unit : EU
HYS3 0.1	It determines the hysteresis value of "R3" module. In order to make this parameter visible, "r3F" parameter should be selected as being ALARM.	Setting Range : LEL (Locked) , 0.1 - 100.0	Unit : EU
HYS4 0.1	It determines the hysteresis value of "R4" module. In order to make this parameter visible, "r4F" parameter should be selected as being ALARM.	Setting Range : LEL (Locked) , 0.1 - 100.0	Unit : EU

While configuring model AC941/491 devices, if PID parameters (P_oP_b , n_oP_b , ζ_t , d_t , ζ_P) are default factory parameters, control outputs operate in ON/OFF mode. In order to begin operating with PID parameters, these parameters should be determined manually or Auto-Tune operation should be done.

Because every process has different characteristics, PID parameters should be different too. Auto-Tune operation calculates the optimum PID parameters and saves them.

Before starting to operate Auto-Tune operation, " $RtSP$ " and " $RtHr$ " parameters should be set and " Rt " parameter should be " on ". If " $RtSP$ " parameter is " OFF ", Auto-Tune operates by using the set value at that time. In order to get the optimum PID parameters, selected set value should be at about the middle of process' whole power.

After having appropriate settings, while in Process-Screen, press the " \square " key for 5 seconds to start the Auto-Tune operation then " Rt " message flashes in "ST" display. In order to have correct results, nobody should interfere with the system. While in Auto-Tune operation, the device calculates and saves new PID parameters after doing ON/OFF control for 2 or 3 oscillations with the determined set value and hysteresis. After finishing the Auto-Tune operation, " Rt " message in display disappears and the device begins to control the system (process) using the new PID parameters. After finishing the Auto-Tune operation, " Rt " parameter in configuration page should be changed to " OFF " state again. While in the Auto-Tune state, pressing the " \times " key cancels the operation.

If user wants a device to operate in ON/OFF mode instead of PID, PID parameters should be set to default factory output.

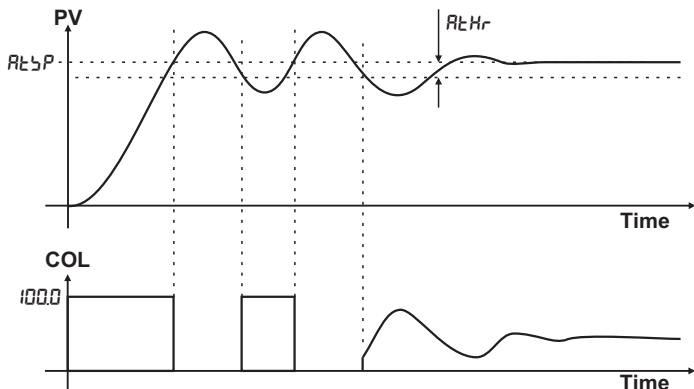

Model AC491/941 devices can operate in two different modes. These are Automatic-Control mode and Manual-Control mode. While in Process-Screen, by pressing the “* ” key for 5 seconds, modes can be changed. The function of “SP” display in Process-Screen is changed as explained below.

Unintended operating mode can be closed by using “RE” and “¬E” parameters in configuration page.

AUTOMATIC CONTROL MODE : Control is done according to the selected set value.

Process Value		<input type="radio"/> R1
Set Value		<input type="radio"/> R2
		<input type="radio"/> R3
		<input type="radio"/> R4
		<input type="radio"/> MN
		<input type="radio"/> SN

In this mode, “MN” led does not indicate.
Set value is selected by using “△” and “▽” keys.

*** 5sec**

MANUAL CONTROL MODE : Control output level is determined as manual.

Process Value		<input type="radio"/> R1
Output Level		<input type="radio"/> R2
		<input type="radio"/> R3
		<input type="radio"/> R4
		<input checked="" type="radio"/> MN
		<input type="radio"/> SN

In this mode, “MN” led indicates.
Output level is determined by using “△” and “▽” keys.

*** 5sec**



Determination of remote set point can be done in three different methods while using model AC491/941 devices. These methods are described separately below:

Determining Set Point by Using Auxiliary Analog Input (Remote Set Point):

"**52F**" parameter that can be accessed in configuration page should be selected as being "**r5P**" and by using the "**52L**", "**52H**" parameters, a scale value should be selected.

Determining Set Point by Using Potentiometer Input (Remote Set Point):

"**53F**" parameter that can be accessed in configuration page should be selected as being "**r5P**" and by using the "**53L**", "**53H**" parameters, a scale value should be selected. Also lower and higher position of potentiometer should be saved by using "**53L**" and "**53H**" parameters.

Determining Set Point by Using Logic Input Module :

There are 2 logic input in "LU" input module in these devices. These inputs are in P1,P2 in order. If "**LUF**" parameter which can be accessed from configuration page is selected as "**55**", then 4 set values are shown as being "**55P.1-55P.4**" in operator page. These are optional set values and according to signal that is received from P1,P2 inputs, by using the table below they are selected as control set values. In automatic mode, selected set value is displayed in ST display and is used as control set value.

If optional set values and remote set value are used in to gather, remote set value is added to 1th optional set point.

P1	P2	Code	Explanation
0	0	55P.1	1th Optional Set Value
1	0	55P.2	2th Optional Set Value
0	1	55P.3	3th Optional Set Value
1	1	55P.4	4th Optional Set Value

Note: "1"s in table states that the input is energized and "0"s states that input is not energized. Inputs are energized by connecting the VS+ point to the related input.

Model AC491/941 devices controls motorized valves in two way. One of them is control with feedback and the other is control without feedback. Proportional motorized valve control without feedback is also called as floating-control.

In order to be able to control motorized valve, one of the relays of device should be used to move the valve in the open direction and the function of this relay should be selected as being "OPN". Other relay should be used to move the valve in the close direction and the function of this relay should be "CLS".

If the valve has potentiometer for nonfeedback operations, this potentiometer should be connected to "S3" input and "33F" parameter should be selected as being "PFb". Also lower and higher values of this potentiometer should be saved by using "33L" and "33H" parameters. If two relays are selected open and close the valve and the system is ready to run, while these parameters are shown in screen, user can control the motor manually by using "↔" and "⇩" keys.

If "33F" parameter is not selected as being "PFb", valve is controlled without feedback(floating-control).

In order to be able to control the proportional valve without feedback, the time pass should be measured from the open position to the close position and it should be entered into the "44E" parameter in configuration page.

Motor position is controlled with PID output. So, PID parameters must be determined. If PID parameters are not determined manually, in order to let the device determine the parameters automatically, Auto-Tune operation should be done.

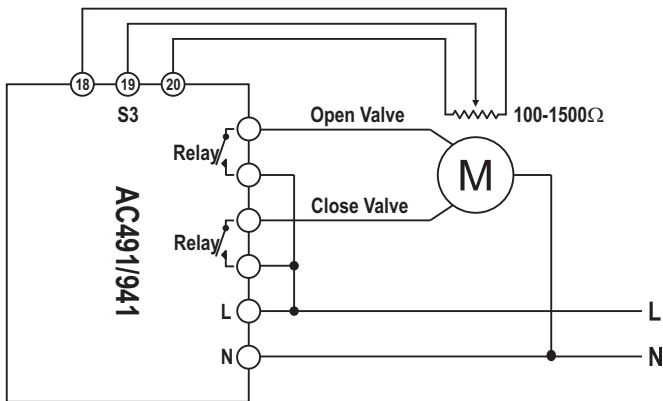

Proportional Motorized Valve Control

Model AC491/941 devices are designed to be communicated in slave mode with MODBUS RTU protocol. All parameters and registers can be accessed with this communication type. Parameters can be read or can be set to a value.

Serial communication is established with Half-Duplex RS485 line. 32 devices can be connected to one RS485 line.

The cable which is used in communication line should be a data cable that is compatible with Half-Duplex RS485 communication and this cable should be connected parallel to all devices as a single line. Both cable ends should be terminated with a appropriate resistance. A communication line which is appropriate for 9600 Bps data transmission speed can be up to 1000m.

Each device on serial communication line should have an unique address between 1 and 255 but all devices in this line should have same speed and parity type. Communication address, speed and parity type of these devices are determined with "Addr, bRÜd ve PrtÜ" parameters which are in configuration page.

Below, you can find information about functions which are supported by MODBUS RTU, parameter addresses and others in tables.

Supported Standard MODBUS RTU Functions:

Function 01 = Read Coils

Function 03 = Read Holding Registers

Function 05 = Write Single Coil

Function 06 = Write Single Register

Function 16 = Write Multiple Registers

BIT Type Parameters (COILS)

Address	Explanation (1 / 0)	Set Perm.
0	Auto-Tune (ON / OFF)	
1	"R1" relay module (ON / OFF)	
2	"R2" relay module (ON / OFF)	
3	"R3" relay module (ON / OFF)	
4	"R4" relay module (ON / OFF)	
5	ERR1 Error (Yes / No)	No
6	ERR2 Error (Yes / No)	No
7	ERR3 Error (Yes / No)	No
8	General Error (Yes / No)	No

REGISTER Type Parameters (REGISTERS)

Adres	Explanation	Setting Range		Mul.	Unit	Set Perm.
0	Valid decimal point	0	3	1		No
1	Measured process value	-1999	9999	10 [^] DP	EU	No
2	Control set value	-1999	9999	10 [^] DP	EU	
3	PID control output level	-1000	1000	10	%	
4	Operating mode	0	2	1		
5	Measured process value from 1. sensor	-1999	9999	10 [^] DP	EU	No
6	Measured process value from 2. sensor	-1999	9999	10 [^] DP	EU	No
7	Measured process value from 3. sensor	-1999	9999	10 [^] DP	EU	No
8	Instantaneous set value	-1999	9999	10 [^] DP	EU	No
9	Valve movement direction	0	2	1		No
10	Valve location	0	1000	10	%	No

Addr.	Explanation	Setting Range		Mul.	Unit.	Set Perm.
20	1.Optional set point	-1999	9999	10^DP	EU	
21	2.Optional set point	-1999	9999	10^DP	EU	
22	3.Optional set point	-1999	9999	10^DP	EU	
23	4.Optional set point	-1999	9999	10^DP	EU	
24						
25						
26						
27						
28	Set value of "R1" module	-1999	9999	10^DP	EU	
29	Set value of "R2" module	-1999	9999	10^DP	EU	
30	Set value of "R3" module	-1999	9999	10^DP	EU	
31	Set value of "R4" module	-1999	9999	10^DP	EU	
32	Control hysteresis value	1	1000	10^DP	EU	
33	Hysteresis value of "R1" module	0	1000	10^DP	EU	
34	Hysteresis value of "R2" module	0	1000	10^DP	EU	
35	Hysteresis value of "R3" module	0	1000	10^DP	EU	
36	Hysteresis value of "R4" module	0	1000	10^DP	EU	

Note: Please contact to producer firm for the communication information about other parameters

To make PID control with your device, you can enter parameters manually or automatically.

If you know the characterise of system, o can enter manually these parameters:

- Proportional band value of positive PID control output P_{oPb} , Proportional band value of negative PID control output n_{oPb} , Integral time constant $\int t$, Differential time constant dt , and Control period sampling time $\int P$.

You can start Auto-Tune function and device will calculate PID control parameters automatically.

To start Auto-Tune process :

- Enter temperature value of process set point to $RtSP$ parameter. This value should be around mid points of process' full power .
- Enter hysteresis value of process set point to tHr parameter. This value arranges the sensitivity of Auto-Tune process.
- Set Rt parameter on .

When the device main screen, press " \square " button for 5 seconds.

While Auto-Tune operation is working, device display shows blinking Rt . This expression fades away when the Auto-Tune process is finished.

To cancel the Auto-Tune operation, press " \square " button while operation is running.

www.ordel.com.tr

Producer and Technical service :

ORDEL Ltd. Şti. Uzayçağı Cad. 1252. Sok. No:12 OSTİM/ANKARA
Tel:+90 312 385 70 96 (PBX) Fax: +90 312 385 70 78

ORDEL